

User's Guide

Agilent Technologies ESA-E Series Spectrum Analyzers Bluetooth™ Measurement Personality

This manual provides documentation for the following instruments:

ESA-E Series

E4402B (9 kHz - 3.0 GHz)
E4404B (9 kHz - 6.7 GHz)
E4405B (9 kHz - 13.2 GHz)
E4407B (9 kHz - 26.5 GHz)



Manufacturing Part Number: E4402-90082

Supersedes: E4402-90052

Printed in USA

August 2002

© Copyright 2001, 2002 Agilent Technologies, Inc.

Notice

The information contained in this document is subject to change without notice.

Agilent Technologies makes no warranty of any kind with regard to this material, including but not limited to, the implied warranties of merchantability and fitness for a particular purpose. Agilent Technologies shall not be liable for errors contained herein or for incidental or consequential damages in connection with the furnishing, performance, or use of this material.

Warranty

This Agilent Technologies instrument product is warranted against defects in material and workmanship for a period of three years from date of shipment. During the warranty period, Agilent Technologies Company will, at its option, either repair or replace products that prove to be defective.

For warranty service or repair, this product must be returned to a service facility designated by Agilent Technologies. Buyer shall prepay shipping charges to Agilent Technologies and Agilent Technologies shall pay shipping charges to return the product to Buyer. However, Buyer shall pay all shipping charges, duties, and taxes for products returned to Agilent Technologies from another country.

Agilent Technologies warrants that its software and firmware designated by Agilent Technologies for use with an instrument will execute its programming instructions when properly installed on that instrument. Agilent Technologies does not warrant that the operation of the instrument, or software, or firmware will be uninterrupted or error-free.

LIMITATION OF WARRANTY

The foregoing warranty shall not apply to defects resulting from improper or inadequate maintenance by Buyer, Buyer-supplied software or interfacing, unauthorized modification or misuse, operation outside of the environmental specifications for the product, or improper site preparation or maintenance.

NO OTHER WARRANTY IS EXPRESSED OR IMPLIED. AGILENT TECHNOLOGIES SPECIFICALLY DISCLAIMS THE IMPLIED WARRANTIES OF MERCHANTABILITY AND FITNESS FOR A PARTICULAR PURPOSE.

EXCLUSIVE REMEDIES

THE REMEDIES PROVIDED HEREIN ARE BUYER'S SOLE AND EXCLUSIVE REMEDIES. AGILENT TECHNOLOGIES SHALL NOT BE LIABLE FOR ANY DIRECT, INDIRECT, SPECIAL, INCIDENTAL, OR CONSEQUENTIAL DAMAGES, WHETHER BASED ON CONTRACT, TORT, OR ANY OTHER LEGAL THEORY.

Safety Information

The following safety notes are used throughout this manual. Familiarize yourself with these notes before operating this instrument.

WARNING **Warning denotes a hazard. It calls attention to a procedure which, if not correctly performed or adhered to, could result in injury or loss of life. Do not proceed beyond a warning note until the indicated conditions are fully understood and met.**

CAUTION Caution denotes a hazard. It calls attention to a procedure that, if not correctly performed or adhered to, could result in damage to or destruction of the instrument. Do not proceed beyond a caution sign until the indicated conditions are fully understood and met.

WARNING **This is a Safety Class 1 Product (provided with a protective earth ground incorporated in the power cord). The mains plug shall be inserted only in a socket outlet provided with a protected earth contact. Any interruption of the protective conductor inside or outside of the product is likely to make the product dangerous. Intentional interruption is prohibited.**

WARNING **No operator serviceable parts inside. Refer servicing to qualified personnel. To prevent electrical shock do not remove covers.**

CAUTION Always use the three-prong AC power cord supplied with this product. Failure to ensure adequate grounding may cause product damage.

Bluetooth™ is a trademark owned by its proprietor & used by Agilent Technologies under license.

Contents

1. Understanding Bluetooth™	
Bluetooth™ Standards	8
The Bluetooth™ Radio Unit	9
The Bluetooth™ Link Control Unit and Link Management	11
Bluetooth™ Glossary	13
What Does The Bluetooth™ Measurement Personality Do?	14
Other Sources Of Measurement Information	15
Application Notes	15
Additional Information	15
2. Getting Started	
Instrument Overview	18
Front-Panel Features	18
Rear-Panel Features	19
Display Annotation	20
Options Required	22
Compatible spectrum analyzers	22
Hardware options required	22
Bluetooth™ Documentation for the ESA-E Series Spectrum Analyzer	24
Spectrum analyzers with Bluetooth™ installed	24
Spectrum analyzers without Bluetooth™ installed	24
Understanding Digital Communications Measurements	25
Agilent ESA Spectrum Analyzers Update	25
Installing Optional Measurement Personalities	26
Active License Key	26
Installing the Licensing Key	26
Using Install Key	27
Installer Screen and Menu	30
3. Setting Up the Bluetooth Mode	
Preparing to Make Measurements	34
Initial Settings	34
Making a Measurement	35
Saving Measurement Results	36
4. Menu Maps	
What You Will Find In This Chapter	38
Menus	39
Detector and Demodulation Menu	39
Display Menu	40
File Menu	41
FREQUENCY Channel Menu	42
Input Menu	43
Marker → Menu	44
Marker Trace Menu	45
MEASURE Menu	46
Measurement Setup Menus	47

Contents

MODE Menu55
Mode Setup Menu56
Trigger Menu57
View/Trace Menu58
5. Front-Panel Key Reference	
Key Descriptions and Locations60
Det/Demod61
Display62
Additional Display Keys62
File63
FREQUENCY Channel64
Input/Output66
Marker68
Monitor Band/Channel68
Output Power, Output Spectrum, and Adjacent Channel Power68
Modulation Characteristic, Initial Carrier Frequency Tolerance, Carrier Frequency Drift, and Modulation Overview68
Marker →69
MEASURE70
Meas Setup71
Modulation Overview (MOV)71
Output Power (OPOW)73
Carrier Frequency Drift (CFDR)76
Monitor Band/Channel (MON)79
Initial Carrier Frequency Tolerance (ICFT)81
Modulation Characteristics (MCH)83
Output Spectrum Bandwidth (OSBW)87
Adjacent Channel Power (ACP)89
MODE91
Mode Setup92
Trigger94
View/Trace95
6. If You Have a Problem	
If you have a Problem98
Before You Call Agilent Technologies100
Check the Basics100
Read the Warranty101
Service Options101
How to Call Agilent Technologies102
How to Return Your Analyzer for Service103
Service Tag103
Original Packaging103
Other Packaging105

1 Understanding Bluetooth™

This chapter introduces you to basics of Bluetooth™ technology and the general functionality of the ESA with the Bluetooth™ measurement personality installed. Sources for additional information on digital communications are also listed.

Bluetooth™ Standards

Bluetooth™ is a limited range RF link technology. It is targeted at voice and data transmission between information appliances for home or business environments. The Bluetooth™ technology eliminates the need for interconnecting cables and enables ad hoc networking among devices.

The Bluetooth™ system consists of a radio unit, a baseband link control unit, and link management software. It also includes higher-level software utilities that focus on interoperability features and functionality. [Figure 1-1](#) is a block diagram for this type of frequency hopping system, showing the baseband controller and the RF transmitter and receiver sections.

Bluetooth™ devices operate in the 2400 - 2483.5 MHz Industrial, Scientific and Medical (ISM) band. This band is unlicensed and available globally.

The design emphasis is on very low power, extremely low cost, and robust operation in the uncoordinated, interference dominated RF environment of the ISM band.

The range is specified as 10 meters, or 100 meters with an additional 20 dB power amplifier. The maximum data rates for a single link are 432.6/432.6 kbps symmetrical, or 721.0/57.6 kbps asymmetrical. The connection topology is basically a star, with a single master and up to 7 slaves.

The radio unit employs Frequency Hopping Spread Spectrum (FHSS). Frequency hopping is pseudo-random, usually at 1600 hops/sec. The signal is nominally at each hop frequency for one 625 us timeslot. Each pair of time consecutive slots constitute a time-division duplex (TDD) frame. The first slot contains a master-to-slave burst, the second may contain a slave-to-master burst.

There are 79 Bluetooth™ channels, each 1 MHz wide. Frequency hopping occurs over all the 79 channels.

Communication is by packet based TDD. Each data packet has a preamble / header / payload format. Various packet types are defined. Various levels of error correction and link security are supported. Circuit and packet modes of operation are supported. Digitized audio and data are supported. Procedures for link control are defined.

The Bluetooth™ Radio Unit

The Bluetooth™ radio unit is shown in Figure 1-1 as the transmitter and receiver sections of the block diagram. The transmitter upconverts the baseband information to the frequency-modulated carrier. Frequency hopping and bursting are performed at this level. Conversely, the receiver downconverts and demodulates the RF signal. Table 1-1 summarizes some of the key RF characteristics of Bluetooth™.

Figure 1-1

Bluetooth Radio

- Bluetooth radio block diagram

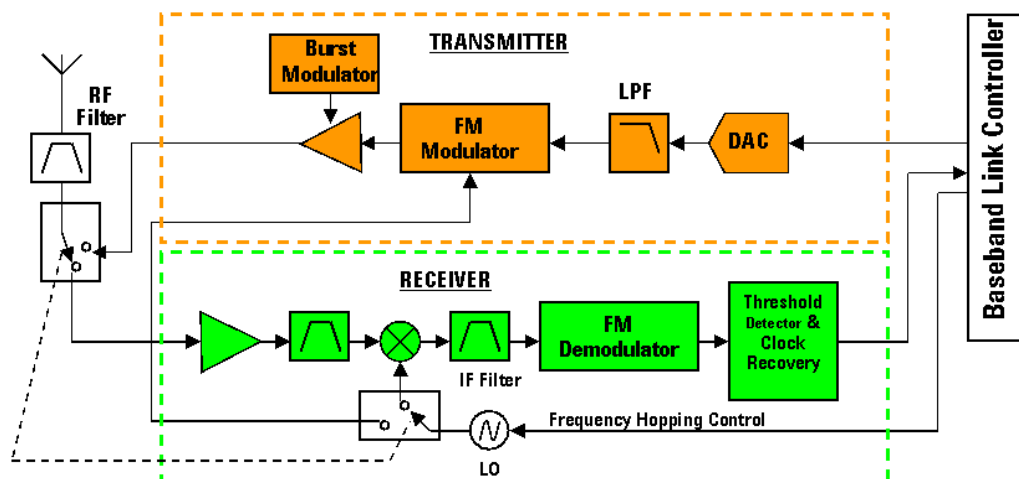

Table 1-1 Bluetooth™ RF Characteristics

Characteristic	Specification	Notes
Carrier Frequency	2400 to 2483.5 MHz (ISM radio band)	$f=2402+k$ MHz, $k=0,\dots,78$
Modulation	0.5 BT Gaussian-filtered 2FSK at 1 Msymbol/s Modulation index: 0.28 to 0.35 (0.32 nominal)	Digital FM scheme The peak frequency deviation allowed is 175 kHz
Hopping	1600 hops/s (in normal operation) ^a 1 MHz channel spacing The system has 5 different hopping sequences: 1. Page hopping sequence 2. Page response sequence 3. Inquiry sequence 4. Inquiry response sequence 5. Channel hopping sequence The first four are restricted hopping sequences used during connection setup. The normal channel hopping sequence is pseudorandom based on the master clock value and device address.	The channel hopping sequence is designed to visit each frequency regularly and with roughly equal probability. It has a periodicity of 23 hours and 18 minutes.
Transmit Power	Power Class 1: 1 mW (0 dBm) to 100 mW (+20 dBm) Power Class 2: 0.25 mW (-6 dBm) to 2.5 mW (+4 dBm) Power Class 3: 1 mW (0 dBm)	Class 1 power control: +4 to +20 dBm (required) -30 to 0 dBm (optional) Class 2 power control: -30 to 0 dBm (optional) Class 3 power control: -30 to 0 dBm (optional)
Operating Range	10 cm to 10 m (100 m with Power Class 1)	
Maximum Data Throughput	The asynchronous channel can support an asymmetric link of maximally 721 kbps in either direction while permitting 57.6 kb/s in the return direction, or a 432.6 kbps symmetric link.	Data throughput is lower than the 1 Msymbol/s rate as a result of the overhead, which is inherent in the protocol.

a. Hop speed may vary depending on packet length.

The Bluetooth™ Link Control Unit and Link Management

The Bluetooth™ link control unit, also known as the link controller, determines the state of the device. It is responsible for establishing the network connections as well as power efficiency, error correction, and encryption.

Bluetooth™ radios may operate as either master or slave units. The link manager sets up the connection between master and slave units and also determines the slave's power saving mode.

The link management software works with the link control unit. Devices communicate among each other through the link manager. [Table 1-2](#) provides a summary of the link control and management functions.

Table 1-2 Link Control and Management Functions

Characteristic	Specification	Notes
Network Connections	The master's link controller initiates the connection procedure and sets the power saving mode of the slave.	
Link Types	Two link types: <ul style="list-style-type: none"> • Synchronous Connection Oriented (SCO) type, primarily for voice • Asynchronous Connectionless (ACL) type, primarily for packet data 	Bluetooth™ can support an asynchronous data channel, up to three simultaneous synchronous voice channels, or a channel that simultaneously supports asynchronous data and synchronous voice. Time-Division Duplexing is used for full duplex operation.
Packet Types	NULL, POLL, FHS - System packets DM1, DM3, DM5 - Medium rate, error-protected data packets DH1, DH3, DH5 - High rate, non-protected data packets HV1, HV2, HV3 - Digitized audio, 3 levels of error protection DV - Mixed data and voice AUX1 - For other uses	The 1, 3 and 5 suffixes indicate the number of time slots occupied by the data burst. Nominal burst lengths: DH1–366 μs DH3–1622 μs DH5–2870 μs
Error Correction	Three error correction schemes: <ul style="list-style-type: none"> • 1/3 rate Forward Error Correction (FEC) code • 2/3 rate Forward Error Correction (FEC) code • Automatic repeat request (ARQ) scheme for data 	Error correction is provided by the Link Manager
Authentication	Challenge-response algorithm. Authentication may be unused, unidirectional, or bidirectional.	Authentication is provided by the Link Manager
Encryption	Stream cipher with secret key lengths of 0, 40, or 64 bits.	
Test Modes	Provides the ability to place the device into test loop-back mode and allows control of test parameters such as frequency settings, power control, and packet type.	

Bluetooth™ Glossary

Hold mode - Power saving mode in which the device is placed in an inactive state, running only an internal timer to occasionally perform a status check.

Master unit - The device in a piconet whose clock and hopping sequence are used to synchronize all other devices in a piconet.

Packet - A single bundle of information transmitted within a piconet. A packet is transmitted on a frequency hop and nominally covers a single time slot, but may be extended to cover up to five slots.

Park mode - Power saving mode in which the device is placed in an inactive state. The device is synchronized to the piconet but does not participate in the traffic. Park mode provides the highest power efficiency.

Payload - The user's voice or data information, which is carried in a packet.

Piconet - The piconet is the smallest Bluetooth™ network structure. A piconet consists of one master and up to seven actively communicating or 200+ inactive non-communicating slaves. The piconet is defined by its hopping sequence.

Power saving mode - Three power saving modes exist; sniff mode, hold mode, and park mode. Each mode puts the slave unit in a varying state of sleep. No data is transferred to or from a slave unit while it is in a power saving mode.

Pre-triggering - A feature which allows examination of the waveform at a point in time prior to the defined trigger point.

Scatternet - Multiple independent and non-synchronized piconets form a scatternet. Devices can share piconets.

Slave units - All devices in a piconet that are not the master. Slave units may be in active mode, in which they are actively communicating with the master, or they may be in an inactive sleep mode.

Sniff mode - Power saving mode in which the device listens to the piconet at a reduced rate to conserve power. Sniff mode is the least efficient power saving mode.

Standby mode - The state of a Bluetooth™ unit which is not connected to a piconet. In this mode, devices listen for messages every 1.28 seconds.

What Does The Bluetooth™ Measurement Personality Do?

When configured with a Bluetooth™ mode personality module, the ESA series spectrum analyzer can be used as a R&D, verification or manufacturing fault finding tool for a Bluetooth™ device. It can also be used to quickly ensure a product under development conforms to regulatory requirements, while also providing RF diagnostic and troubleshooting capability.

The Bluetooth™ measurement personality supports the following industry standards:

- ETS 330-328
- ETS 330-339

NOTE

These standards are continually being updated by the communications industry. The software performs to the standard/date shown under **Mode Setup, Radio**.

When you select the standard format for use, the instrument automatically makes measurements using the measurement methods and limits defined in the standards. Detailed measurement results are displayed allowing you to analyze Bluetooth™ system performance.

Measurement parameters may be altered for specialized analysis. This is done within narrow limits because the standards specify the test methods and settings.

The instrument makes the following Bluetooth™ one-button measurements (measurements activated by a single key press):

- Modulation Overview
- Output Power
- Carrier Frequency Drift
- Monitor Band/Channel
- Initial Carrier Frequency Tolerance
- Modulation Characteristics
- Output Spectrum Bandwidth
- Adjacent Channel Power (ACP)

Other Sources Of Measurement Information

Application Notes

The following application notes describe digital communications measurements in much greater detail than discussed in this User Guide:

- Application Note 1333-1
Bluetooth™ RF Measurements Fundamentals
Agilent Technologies
part number 5988-3760EN
- Application Note 150
Spectrum Analyzer Basics
part number 5952-0292

Additional Information

- Additional Bluetooth™ measurement application information is available from the following URL or from your local Agilent Technologies sales and service office.

<http://www.agilent.com/find/bluetooth/>

Understanding Bluetooth™
Other Sources Of Measurement Information

2 **Getting Started**

This chapter introduces you to basic features of the instrument, including the front panel keys, rear panel connections, and display annotation. Equipment required for Bluetooth™ measurements, available documentation, and processes for installing and uninstalling applications are also described.

Instrument Overview

This section provides information on only Bluetooth™ mode features. For those features not described here, refer to the Agilent ESA Spectrum Analyzers User's Guide.

Front-Panel Features

For further information on the features mentioned in the following section, refer to Chapter 5 of this document.

Figure 2-1 Front-Panel Feature Overview

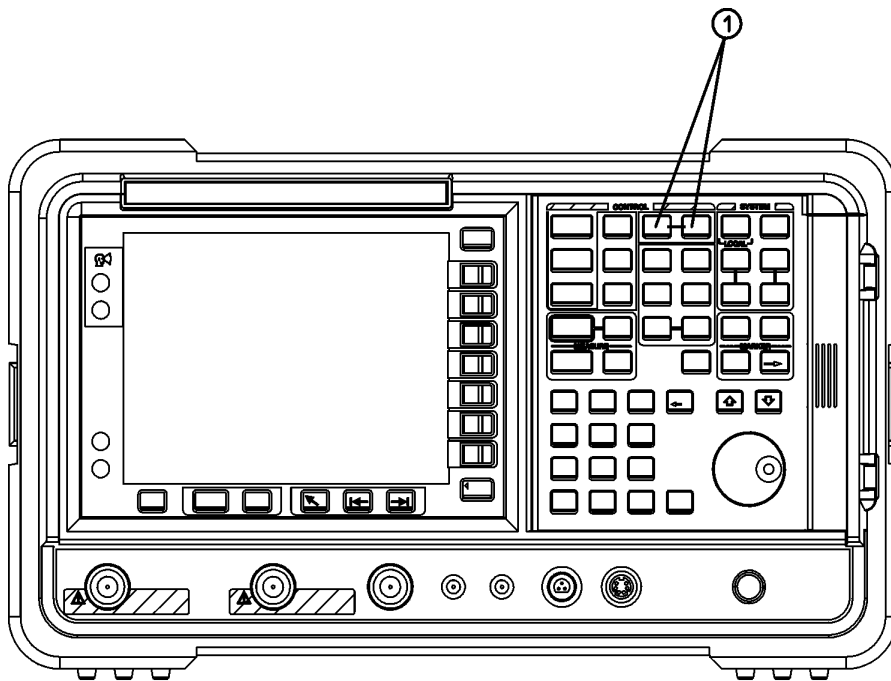

p1728b

- 1 Mode keys** These keys allow you to select the measurement mode and mode parameters such as input and trigger settings.
- **MODE** accesses menu keys to select the instrument mode. Each mode is independent of all other modes.
 - **Mode Setup** accesses menu keys that allow you to configure the parameters specific to the current mode and affects all measurements within that mode.

Rear-Panel Features

This section provides information on Bluetooth™ rear panel features only. For those features not described here, refer to the ESA-E Series Spectrum Analyzers User's Guide.

Figure 2-2 Rear-Panel Feature Overview

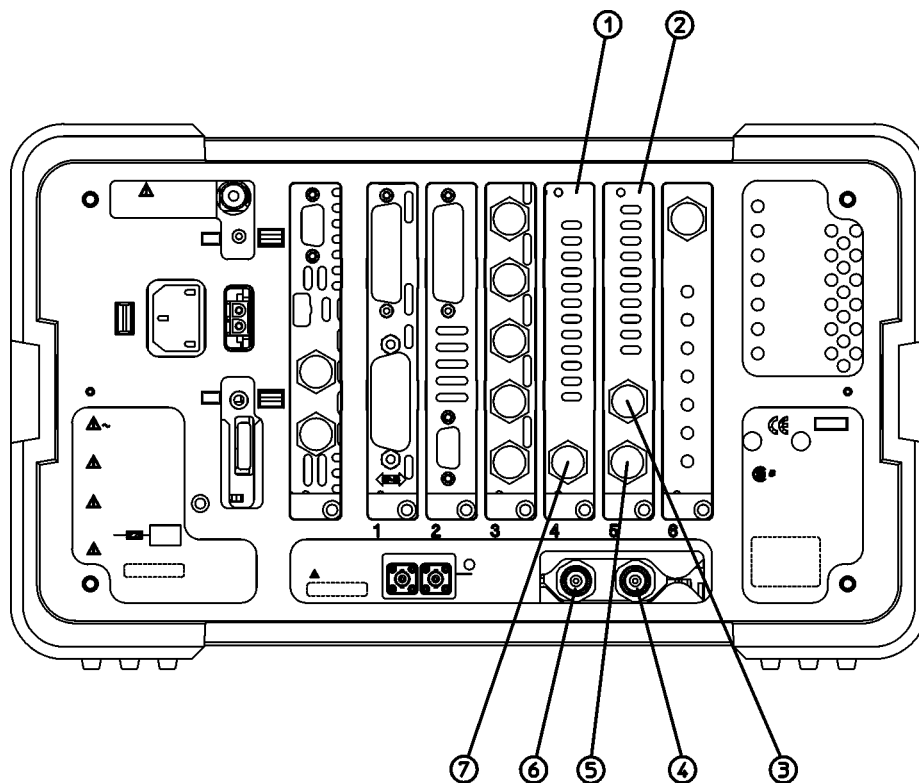

pl729b

- | | |
|----------------------------|--|
| 1 DSP and Fast ADC | DSP and Fast ADC (<i>Option B7D</i>) provides digital signal processing and fast ADC. |
| 2 RF Comms Hardware | RF communications hardware (<i>Option B7E</i>) provides an RF Burst Carrier Trigger. |
| 3 EXT REF IN | Accepts an external 1 MHz to 30 MHz reference frequency source. |
| 4 10 MHz REF IN | Accepts an external frequency source to provide the 10 MHz, -15 to +10 dBm frequency reference used by the analyzer. |
| 5 10 MHz Out | Provides a 10 MHz, 0 dBm minimum, timebase reference signal phase locked to the Ext Ref In. |
| 6 10 MHz REF OUT | Provides a 10 MHz, 0 dBm minimum, timebase reference signal. |
| 7 Ext Frame Sync | Accepts an external 0 to 5 V TTL trigger. |

Display Annotation

This section describes Bluetooth™ screen annotations which differ from SA mode annotations. Refer to the ESA-E Series Spectrum Analyzers User's Guide for information on screen annotations not described here.

The following screen provides an example of a screen annotation:

Figure 2-3 Screen Annotation: Example

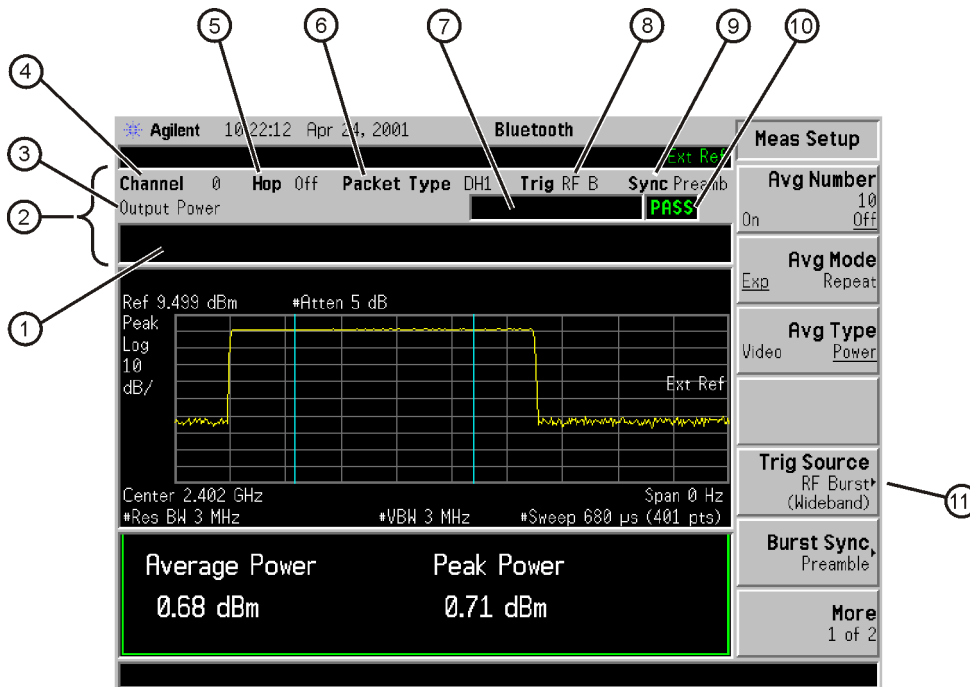

pt819b

NOTE

Annotations are not always identical for different measurement screens and the annotations displayed depend on what is required to display critical measurement parameters. To view examples of the measurement displays, refer to the ESA-E Series Spectrum Analyzers Bluetooth™ Measurement Personality Measurement Guide.

- | | | |
|---|-----------------------------|---|
| 1 | Active Function Area | Displays parameter entries. If you press a key which activates a function, the parameter description and value will appear in the active function area. |
| 2 | Measurement Bar | Displays information about measurements including some mode setup parameters. |
| 3 | Current Measurement | Displays the name of the current measurement. |
| 4 | Channel | Indicates which RF channel is currently selected. |
| 5 | Hop | Indicates whether the hopping mode is turned on or off. |

6	Packet Type	Indicates which type of packet is currently selected.
7	Averaging Indicator	Displays the number of the current average (averaging progress) when averaging is turned on.
8	Trig Source	Displays the triggering mode selected for the current measurement. Possible values are External, Free Run, RF Burst and Video.
9	Burst Sync	Displays the type of burst sync selected for the current measurement. Possible values are Preamble, RF Amptd, and None.
10	Pass/Fail Status	Indicates the status of the measurement limit pass/fail test when one or more limit test function is turned on.
11	Branch Key	A softkey with a small triangle opens another menu of choices when pressed.

Options Required

Installing the Bluetooth™ measurement personality firmware and making the associated measurements require certain basic equipment. This section lists Bluetooth™ compatible Agilent ESA Spectrum Analyzers and required hardware options.

Compatible spectrum analyzers

The Bluetooth™ measurement personality is not compatible with all ESA spectrum analyzer models. [Table 2-1](#) lists the models that are compatible and the upper frequency range of each.

Table 2-1

Bluetooth™ Compatible Agilent ESA Spectrum Analyzers

Model Number	Upper Frequency Range
E4402B	3 GHz
E4404B	6.7 GHz
E4405B	13.2 GHz
E4407B	26.5 GHz

Hardware options required

Additional hardware options must be installed in the spectrum analyzer before Bluetooth™ measurements can be made. [Table 2-2](#) lists the hardware options available and the measurements that they enable.

Not all of the options can be installed by the user. Some of the options require that the instrument be returned to the factory or an Agilent Technologies service center. In addition, some of the options require Performance Verification and Adjustments to be performed after installation. Refer to [Table 2-2](#) for option specific information.

NOTE

When transporting the instrument, use the original packaging or comparable packaging. If the shipping container is damaged, any part is missing, or you do not have an appropriate shipping container, notify Agilent Technologies at one of the locations shown on [Table 6-1 on page 102](#).

Table 2-2 Bluetooth™ Hardware Options and measurements

Required/recommended option	Option Number	Measurement
Bluetooth™ Measurement Personality	228	Required for all measurements.
Memory extension	B72	
DSP and Fast ADC	B7D ^a	Required for fast sampling and RF Burst Carrier trigger Note: these options must be ordered together. Required if option AYX is not ordered.
RF Communications Hardware	B7E ^a	
Fast Time Domain Sweep	AYX	Required if options B7D/B7E are not ordered.
Bluetooth™ Demod Board	106	Required for Modulation Overview, Carrier Frequency Drift, Modulation Characteristics, and Initial Carrier Frequency Tolerance.
Narrow Resolution Bandwidths	1DR	Required for narrow resolution bandwidths in Monitor Band/Channel and Modulation Characteristics.

a. Factory installation, calibration required.

NOTE If the appropriate hardware is not present, the measurement softkey under the **Measure** menu will be grayed out and that measurement will not be available.

Bluetooth™ Documentation for the ESA-E Series Spectrum Analyzer

Spectrum analyzers with Bluetooth™ installed

When you purchase your instrument already loaded with the Bluetooth™ measurement personality, you receive the following materials:

Table 2-3 Personality Documentation

Part Number	Part Description	Notes
Refer to the ESA WEB site for the current part number.	<i>User's Guide ESA-E Series Spectrum Analyzers Bluetooth™ Measurement Personality</i>	Option 228 manuals
	<i>Bluetooth™ Quick Reference Card</i>	Option 228 manuals
	<i>Measurement Guide ESA-E Series Spectrum Analyzers Bluetooth™ Measurement Personality</i>	Option 228 manuals
	<i>Programming Commands ESA-E Series Spectrum Analyzers Bluetooth™ Measurement Personality</i>	Option 228 manuals

Spectrum analyzers without Bluetooth™ installed

If your instrument is ordered without measurement personalities installed, you can order the Bluetooth™ measurement personality as Option 228 instrument upgrade package. With the purchase of a personality option upgrade, you receive the documents listed in [Table 2-3](#) and the document shown in [Table 2-4](#).

Table 2-4 Personality Documentation

Part Number	Part Description	Notes
Refer to the ESA WEB site for the current part number.	<i>Agilent ESA Series Spectrum Analyzers Documentation and Instrument Driver CD-ROM</i>	Does not include service documentation or software

Understanding Digital Communications Measurements

Additional measurement application information is available through your local Agilent Technologies sales and service office. Refer to “[Other Sources Of Measurement Information](#)” on [page 15](#) for applicable application notes.

Agilent ESA Spectrum Analyzers Update

For the latest information about this instrument (including firmware upgrades, application information, and product information) please visit the URL listed below

Updating the Firmware

Updated versions of the ESA-E Series Spectrum Analyzer firmware will be available via several sources. Information on the latest firmware revision can be accessed from the following URL:

<http://www.agilent.com/find/esa/>

Installing Optional Measurement Personalities

Active License Key

The measurement personality software you have purchased with your instrument has been installed and the license key has been enabled at the factory. With any future purchase of a new personality software, you will receive a certificate that displays the unique license key number. The license key enables you to install, or reinstall, any measurement personality you have purchased.

Installing the Licensing Key

If you are installing a new option, follow these steps to install the unique license key number for the measurement personality software that you want to install in your instrument:

1. Press **System, More, Licensing, Option**.

When you press **Option**, the alpha editor will be activated. For instructions on using the alpha editor, refer to the *Agilent ESA Spectrum Analyzers User's Guide*.

2. Use the alpha editor to enter the three letter designation for the software option that you wish to install in the instrument.
3. Press **Done** on the alpha editor menu.
4. Press **License Key**.

When you press **Licensing Key**, the alpha editor will be activated. For instructions on using the alpha editor, refer to the *Agilent ESA Spectrum Analyzers User's Guide*.

5. Use the alpha editor to enter the 12 character licensing key number for the software option that you wish to install in the instrument.
6. Press **Done** on the alpha editor menu.
7. Press **Activate** to turn on the licensing key. You may now install the measurement personality option software.

Using Install Key

You may want to install a software revision, install new measurement software or reinstall measurement software that you have previously uninstalled, or uninstall measurement software. Before you can install software, you will need a set of installation diskettes.

If you have ordered a measurement personality, you will receive the installation disk set in the option upgrade package. If you are updating an existing, previously installed measurement option, you may order the diskettes from Agilent Technologies or create a set from the Agilent internet site shown in [“Updating the Firmware” on page 25](#). A set of diskettes can be ordered from your local Agilent Technologies call center. Refer to [Table 6-1 on page 102](#) for the location of these centers. To create a disk set refer to [“Creating Software Installation Disks”](#) below.

Creating Software Installation Disks

To create the installation disks on-line, visit the Agilent internet site shown in [“Updating the Firmware” on page 25](#). Follow the instructions provided on the internet site for downloading the current measurement personalty software and creating the installation disk set. The instructions for creating the disk set will step you through the process to create a firmware disk set when you create the measurement personalty software disk set. (A firmware update may be needed to ensure that the firmware and the software are compatible.) After you have created the disk set, follow the on-line instructions to install the firmware. After successfully installing the firmware update, proceed with the following instructions for installing the measurement personalty software in your instrument.

Installing Personality/Software Options

This procedure gives steps to install a new software option in an ESA-E Series Spectrum Analyzer using the internal floppy drive of the instrument. Screen messages display the update progress and give directions. The instrument will not need to be re-calibrated after this procedure since no changes are made to calibration or adjustment files.

If you have a problem with the installation process, refer to [“Troubleshooting the Installer” on page 29](#).

NOTE

When the installer starts up, it examines the instrument to ensure that all the required software and hardware options are present. If they are not, the installer will generate an error and you will not be able to install the personality.

1. If this is the installation of new personality option software, you must enter the License Key for the new option. For instructions on entering the License Key, refer to the [“Installing the Licensing Key”](#) on page 26.

When you have completed entering the license key number, continue with the next step.

2. Insert disk one of the installation disk set into the disk drive located on the right side of the ESA front panel.
3. Press **System, More, Personalities**, and **Install**. The instrument will then load the installer from the floppy drive. If there is no floppy in the drive, the incorrect disk is inserted, or there is no installer on the disk, the error “No install disk present in disk drive” will be shown.

Once the instrument has loaded the installer, the screen will change to the installer screen and the **Install Pers.** menu will be shown. For more information on the installer screen and menu, refer to [“Installer Screen and Menu”](#) on page 30.

4. When the installer first starts up, it will show a popup message. Select **Verify Disks**.

NOTE

Once the installer has begun installing a personality, any error will cause the whole personality (including a previously installed version) to be removed from the instrument. Because of this, it is very important that you verify the disks prior to installing them. If any of the disks or files are bad, you will not be able to use the personality until you obtain a new installation disk set and run the install using them.

5. When prompted, insert the next disk and press **Verify Disks** again.

When Verify Disks is running, the **Install Now** and **Exit Install** keys will be grayed out.

6. When the verification is complete, press **Install Now** and the installation of the personality will begin. Some of the disks may take only a short time to load or be skipped entirely, while others can take up to about 30 minutes to load.

When the installer is running, the **Verify Disks** and **Exit Install** keys will be grayed out.

7. When prompted, insert the next disk and press **Install Now** again.

8. Once the installation is complete, press **Exit Install**.

Troubleshooting the Installer

If the installation process stalls or fails in another way, follow these steps to resolve your problem.

1. If the instrument stops the update process before all the disks are loaded, proceed as follows:
 - a. Press **Exit Install** to abort the process.
 - b. Return to step 2 under “[Installing Personality/Software Options](#)” and start the installation process again.
2. If the instrument fails after repeating the installation procedure, get in touch with your nearest Agilent call center listed in [Table 6-1 on page 102](#) for assistance. Please provide the following information:

Model Number:

Serial Number:

State that you are having trouble installing a software option update.

Installer Screen and Menu

The illustration shown below is a typical DLP installer screen. The top portion of the install screen is a table in which the files that are about to be installed are listed. The bottom portion of the screen contains information needed to track the progress of the install.

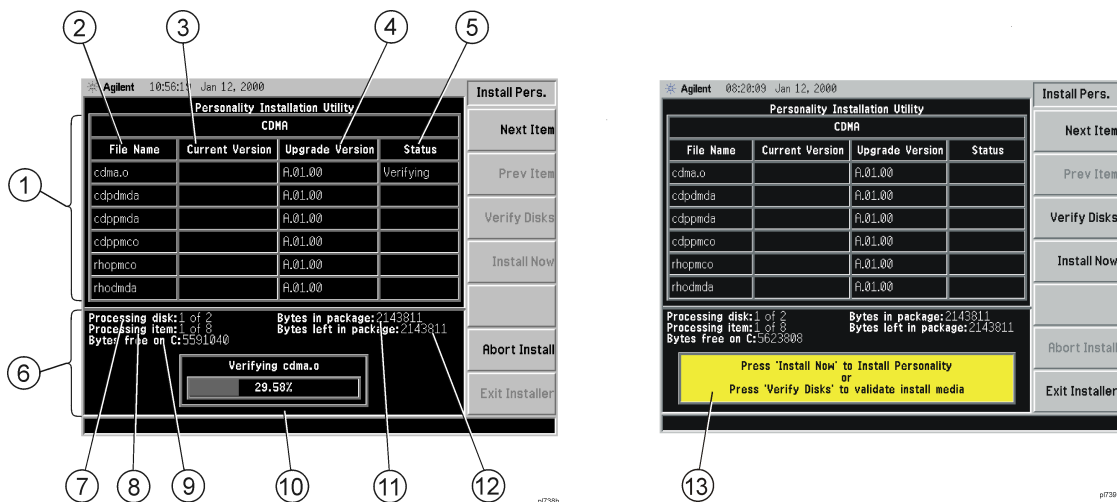

- 1 **File Table** displays the files to be installed and various file information. If there are more than six files, **Next Item** and **Prev Item** allow you to scroll the table to view additional items.
- 2 **File Name** displays the name of the files on the installation disk.
- 3 **Current Version** displays the version of the file that is currently installed in the instrument. (This field will be blank if this file is not currently installed in the instrument or if the file is a data file that has no version.)
- 4 **Upgrade Version** shows the version of the file on the install disk. This is the version of the file that will replace the currently installed version.
- 5 **Status** is updated to reflect what the installer is doing to the current file as the install progresses. The valid messages seen in this column are listed in [Table 2-5 on page 31](#).
- 6 **Data Field** contains a status bar and various status information.
- 7 **Processing disk** shows the disk that is currently being read.
- 8 **Processing item** shows the file that is being processed by item number.
- 9 **Bytes free on C** is the number of bytes currently free on the instrument C: drive.
- 10 **Status Bar** contains a status bar that runs from 0 to 100% and tracks the progress of the current step. A message line displays the step that is currently being executed.

- 11 **Bytes in package** lists the number of bytes in the install package.
- 12 **Bytes left in package** lists the number of bytes left to be read.
- 13 **Message and error** popup window will display on top of the status bar. Information in this box will prompt you for action required to proceed to the next phase of the installation. It may also inform you of errors in the installation process and may prompt you for action required to correct the problem.

Table 2-5 **Installer Status Messages**

Failed	This means that something has gone wrong while processing this item. It is a fatal error and the installation can not be completed. The installer will try to get the system back to a good state which may entail completely removing the currently installed personality.
Loading	The file is currently being copied from the install media to the instrument's file system.
Verifying	This may mean one of two things: <ol style="list-style-type: none"> 1. If "Verify Disks" was pressed then Verifying means that the installer is currently reading the install media and comparing the known checksums to ensure the data is good. 2. If "Install Now" was pressed, then Verifying means that the installer is reading what was just loaded to ensure the checksum is correct.
Loaded	This means that the data has been placed on the instrument disk but has not yet been registered with the firmware.
Installed	This means that the data has been loaded into the instrument and registered. The install for this file is complete.
Skipping	This means that the installer has determined that this file does not need to be loaded into the instrument.

Getting Started
Installing Optional Measurement Personalities

3 Setting Up the Bluetooth Mode

This chapter introduces the basic measurement procedure including mode setup and changing measurement frequency.

Preparing to Make Measurements

At initial power up, the analyzer is in spectrum analyzer (SA) mode, with the Meas Off selected in the **MEASURE** menu and the **FREQUENCY Channel** menu displayed.

To access the Bluetooth measurement personality, press the **MODE** front panel key and select the **Bluetooth** menu key.

Initial Settings

Before making a measurement, make sure the mode setup, measurement setup, and frequency channel parameters are set to the appropriate settings. For further information refer to “[Mode Setup](#)” on page 92, “[Meas Setup](#)” on page 71, and “[FREQUENCY Channel](#)” on page 64.

- **Resetting all parameters:**
To set all instrument parameters (including mode setup and measurement setup parameters) to factory default values, press the **Preset** front panel key. Note that the mode is changed from Bluetooth to SA when the **Preset** front panel key is used and the **Preset Type** is set to **Factory**. If the **Preset Type** is set to **Mode**, only the parameters associated with the current mode will be preset and the mode will not be changed. After using **Preset**, you must use the **MODE** key to return to the Bluetooth mode. The **Preset** front panel key can also be used to return the instrument to a set of user preset values. Refer to the ESA Spectrum Analyzers User’s Guide for further information.
- **Resetting mode setup parameters:**
Mode setup parameters apply to all measurements in the Bluetooth mode. To reset them to factory default values, press **Mode Setup** then **Restore Mode Setup Defaults**.
- **Resetting measurement setup parameters:**
Measurement setup parameters affect the current measurement only. To reset them to factory default values (for the current measurement only), press **Meas Setup** then **Restore Meas Defaults**.

Making a Measurement

Bluetooth measurements are intended to be used as “one button” measurements. This means that the appropriate measurement can be selected and run by a single key press once the instrument has been connected to the equipment to be tested. The measurement is made automatically using default parameters defined by the selected standard and the tuning plan.

Even though the measurements are designed as one-button measurements, you may change the default settings using various setup keys. However, changing the default settings may produce measurement results that are outside of the parameters of the selected standard and tuning plan requirements.

Most measurements can be performed using the simple four-step procedure outlined in the table below. Most measurements are performed using only the primary keys listed in conjunction with a minimum of setup keys. Measurement setup keys (**Meas Setup**) can be used for non-standards compliant testing. For more information see “[Initial Settings](#)” above.

Step	Primary Key	Setup Keys	Related Keys
1. Select and setup mode	MODE	Mode Setup, Frequency Channel	System
2. Select and setup measurement	MEASURE	Meas Setup, Restore Meas Defaults	Meas Control, Restart
3. Select and setup view	View/Trace	Span X Scale, Amplitude Y Scale, Display	Marker, Search
4. Saving and printing results	File Print	Print Setup	Save

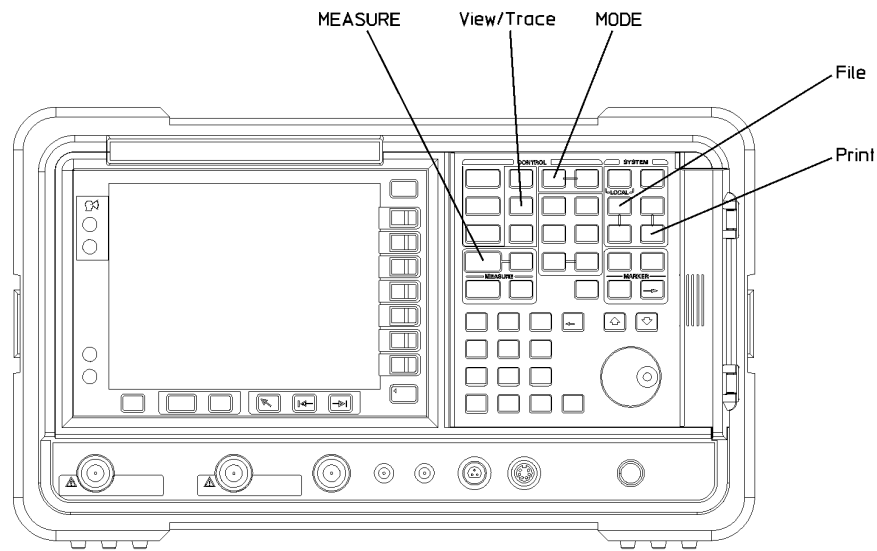

r171b

Saving Measurement Results

To save measurement results, follow the process shown below. For additional information on file management in the spectrum analyzer, refer to the *ESA Spectrum Analyzers User's Guide*.

1. Press **File**, **Save**, **Type**, **More**, and **Measurement Results**.
2. If you want to change the file name, press **Name**, and use the Alpha Editor to enter the new name. For more information on using the Alpha Editor, refer to the *ESA Spectrum Analyzers User's Guide*.
3. The default directory is the C: drive. If you want to change the file directory, press **Dir Up** (or **Dir Select**) and use the up or down arrows to select the desired directory and then press **Dir Select**.
4. Press **Save Now** to complete the file saving process.
5. If you have used the default file name and wish to save additional measurement results, press **Save**. The current measurement result will be saved with the next default file name.
6. If you have not used the default file name and wish to save additional measurement results, repeat steps 1 through 3.

4 Menu Maps

This chapter provides a visual representation of the front panel keys and their associated menu keys. For function key descriptions, refer to [Chapter 5](#) , “Front-Panel Key Reference.”

What You Will Find In This Chapter

This chapter provides menu maps for the front panel keys having associated menus. The key menus appear in alphabetical order as follows:

Det/Demod	page 39
Display	page 40
File	page 41
FREQUENCY Channel	page 42
Input/Output	page 43
Marker →	page 44
Marker Trace	page 45
MEASURE	page 46
Measurement Setup—Modulation Overview	page 47
Measurement Setup—Output Power	page 48
Measurement Setup—Carrier Frequency Drift	page 49
Measurement Setup—Monitor Band/Channel	page 50
Measurement Setup—Initial Carrier Frequency Tolerance	page 51
Measurement Setup—Modulation Characteristics	page 52
Measurement Setup—Output Spectrum Bandwidth	page 53
Measurement Setup—ACP	page 54
MODE	page 55
Mode Setup	page 56
Trig	page 57
View/Trace	page 58

Menus

Detector and Demodulation Menu

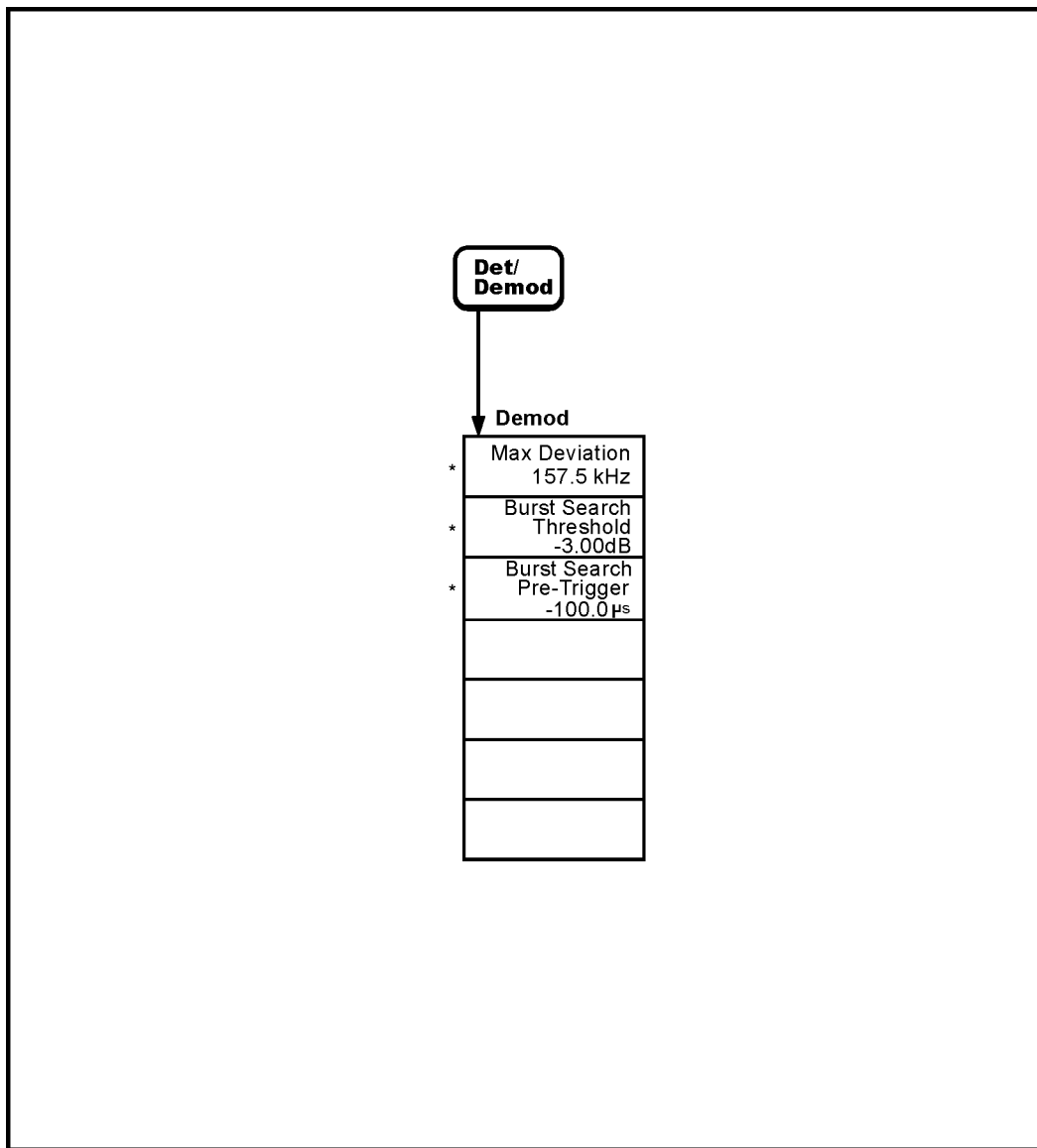

* An active function that allows data entry.

pt81b

Display Menu

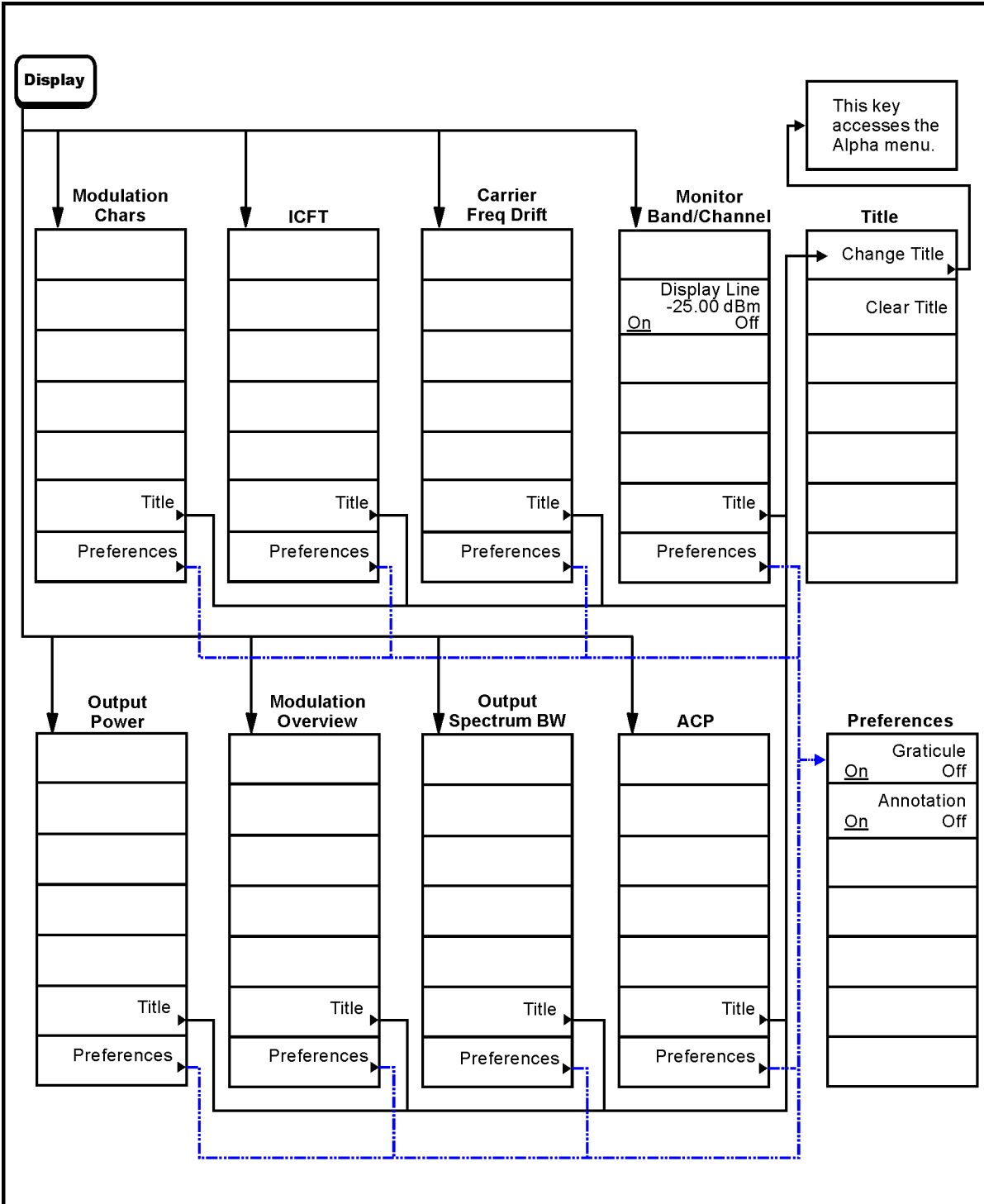

pt82b

File Menu

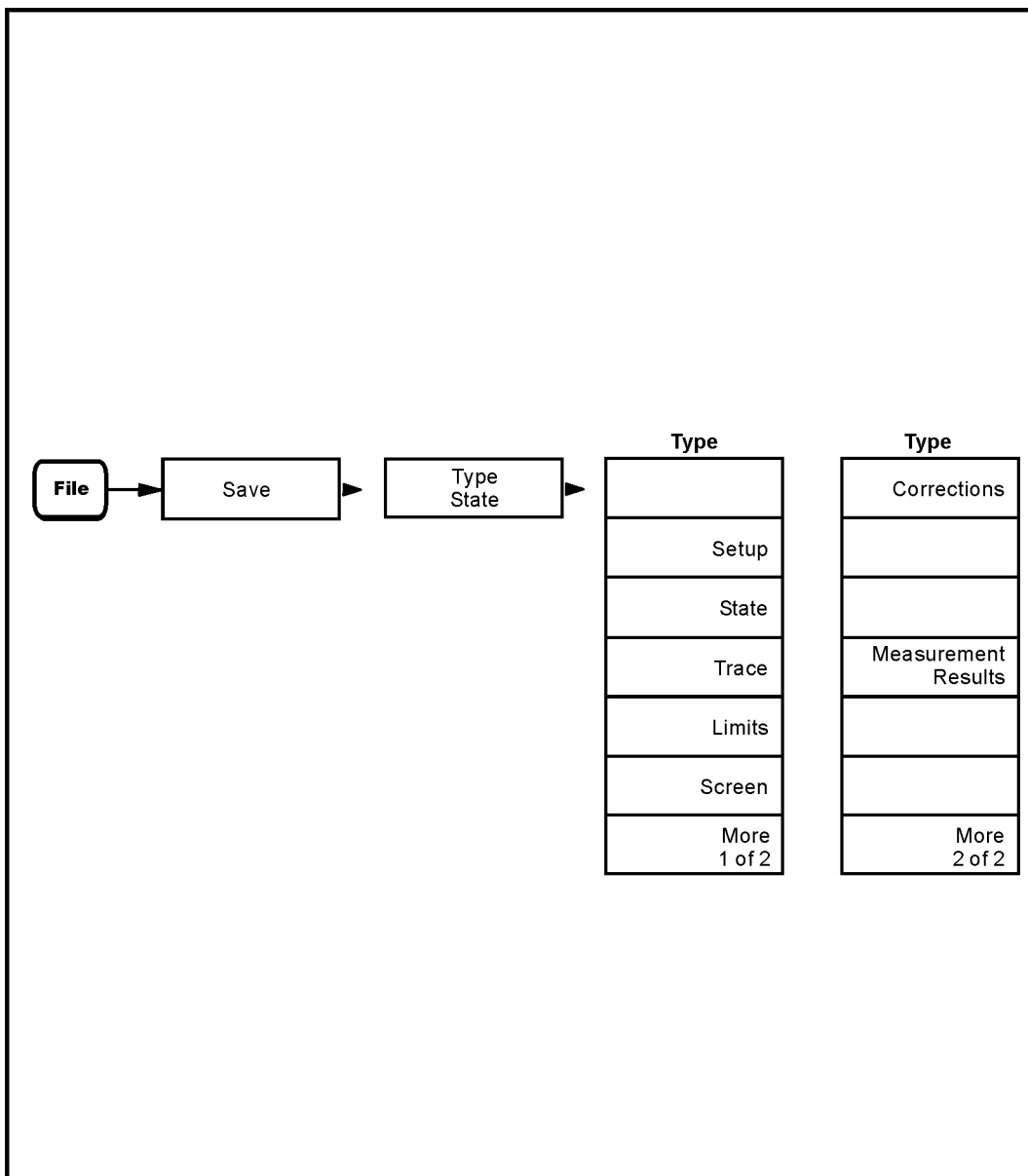

pt816b

FREQUENCY Channel Menu

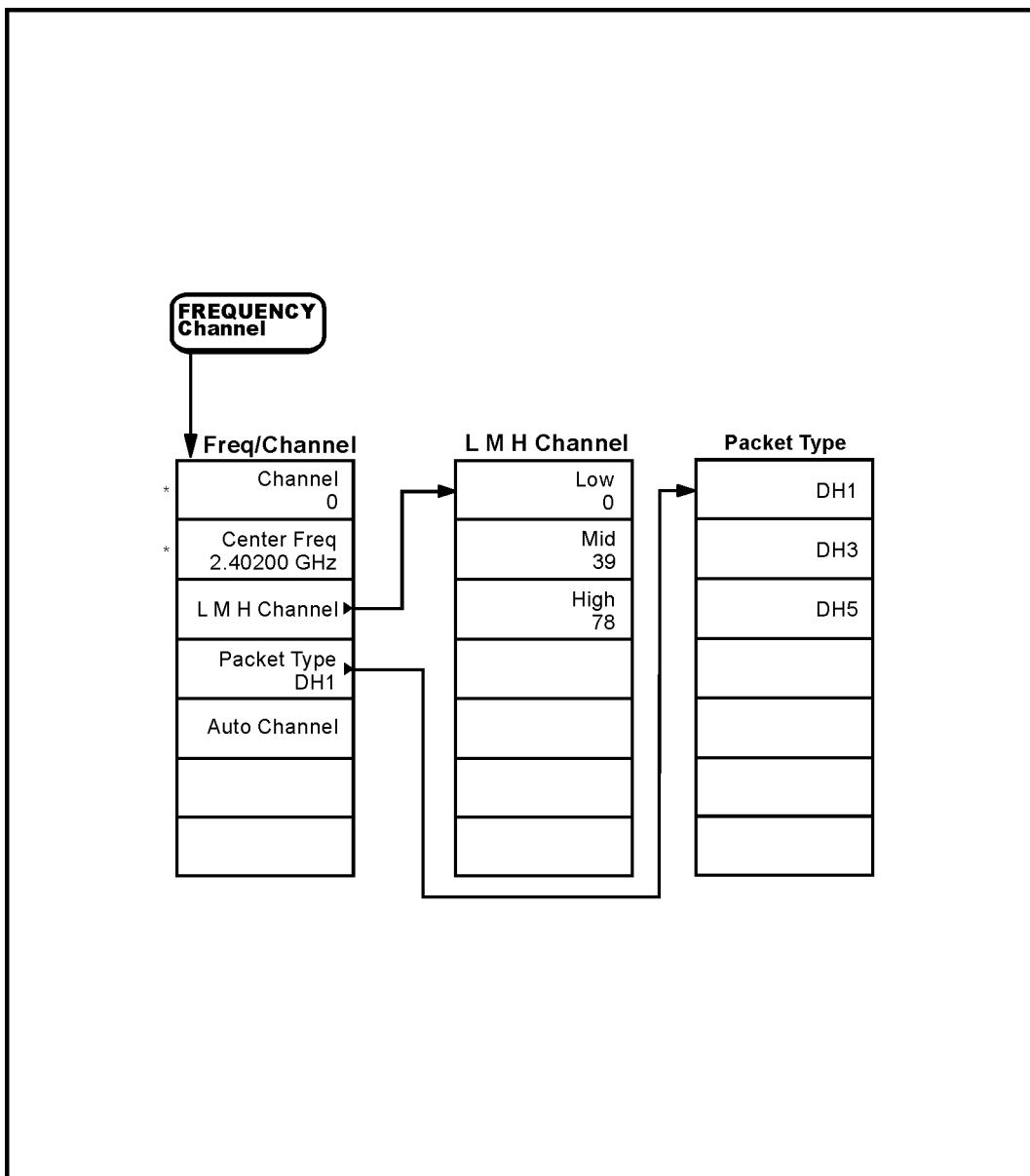

* An active function that allows data entry.

pt83b

Input Menu

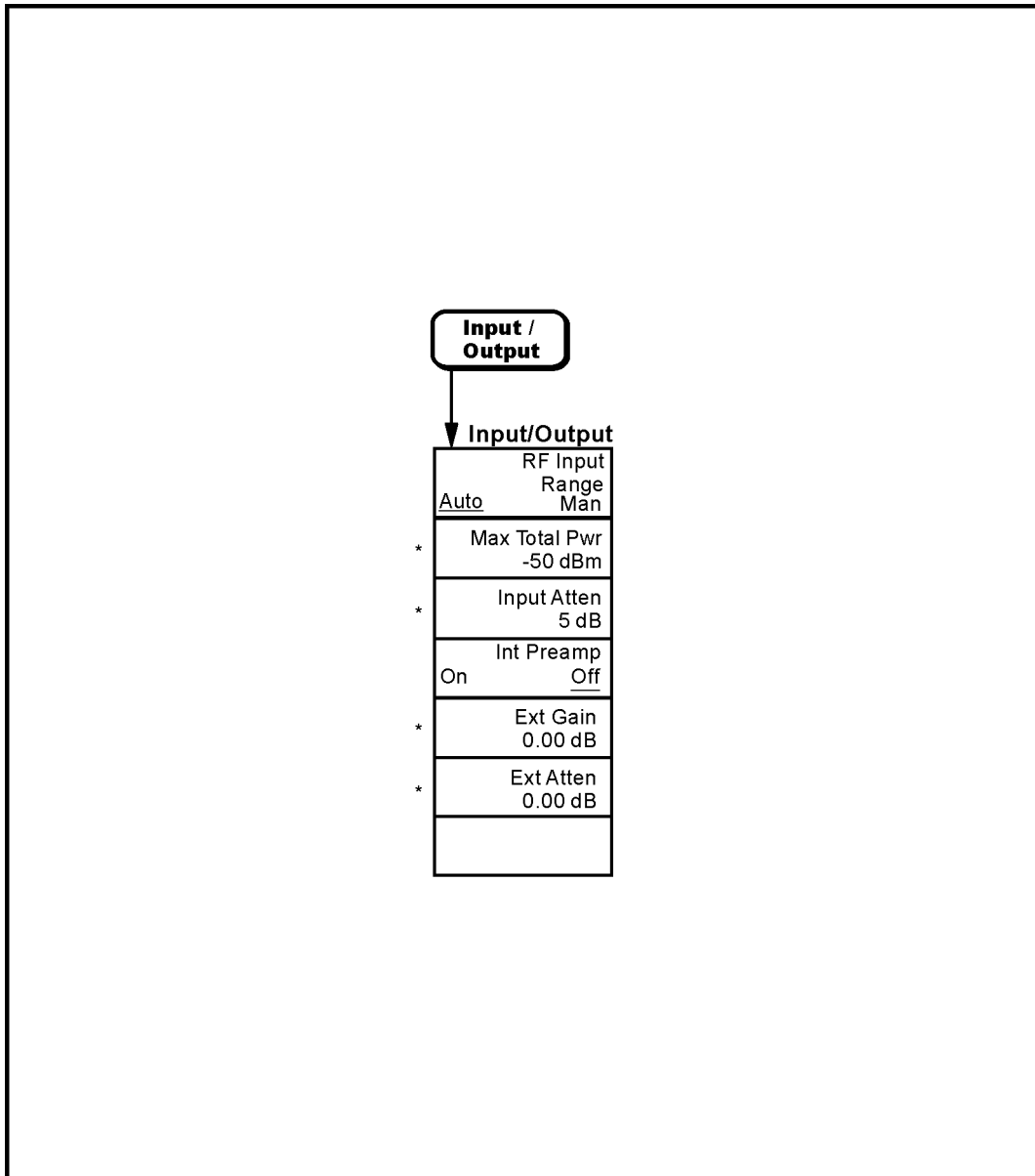

* An active function that allows data entry.

pt84b

Marker → Menu

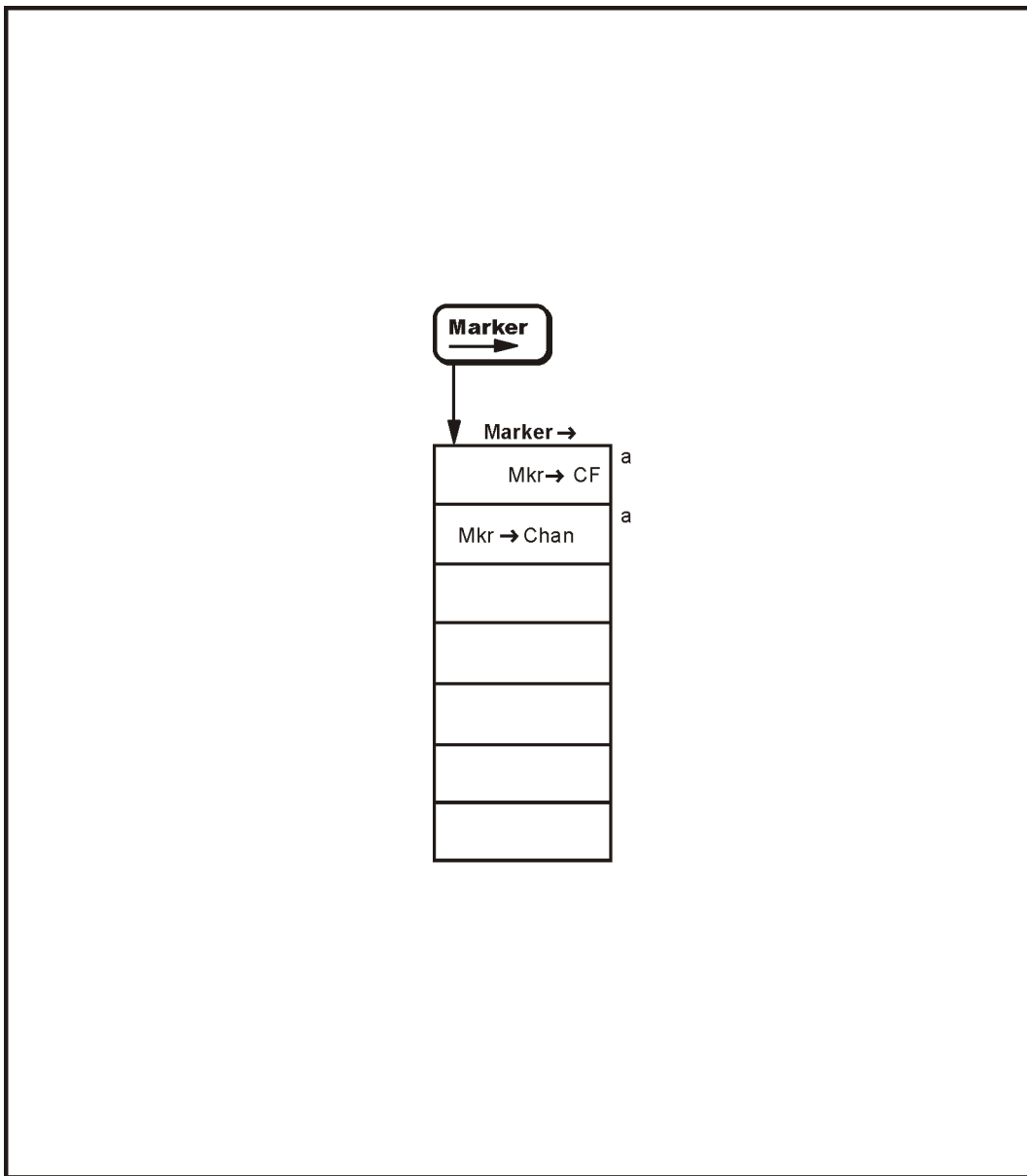

a. Not active when **span** is set to zero (Zero Span)

pt825b

Marker Trace Menu

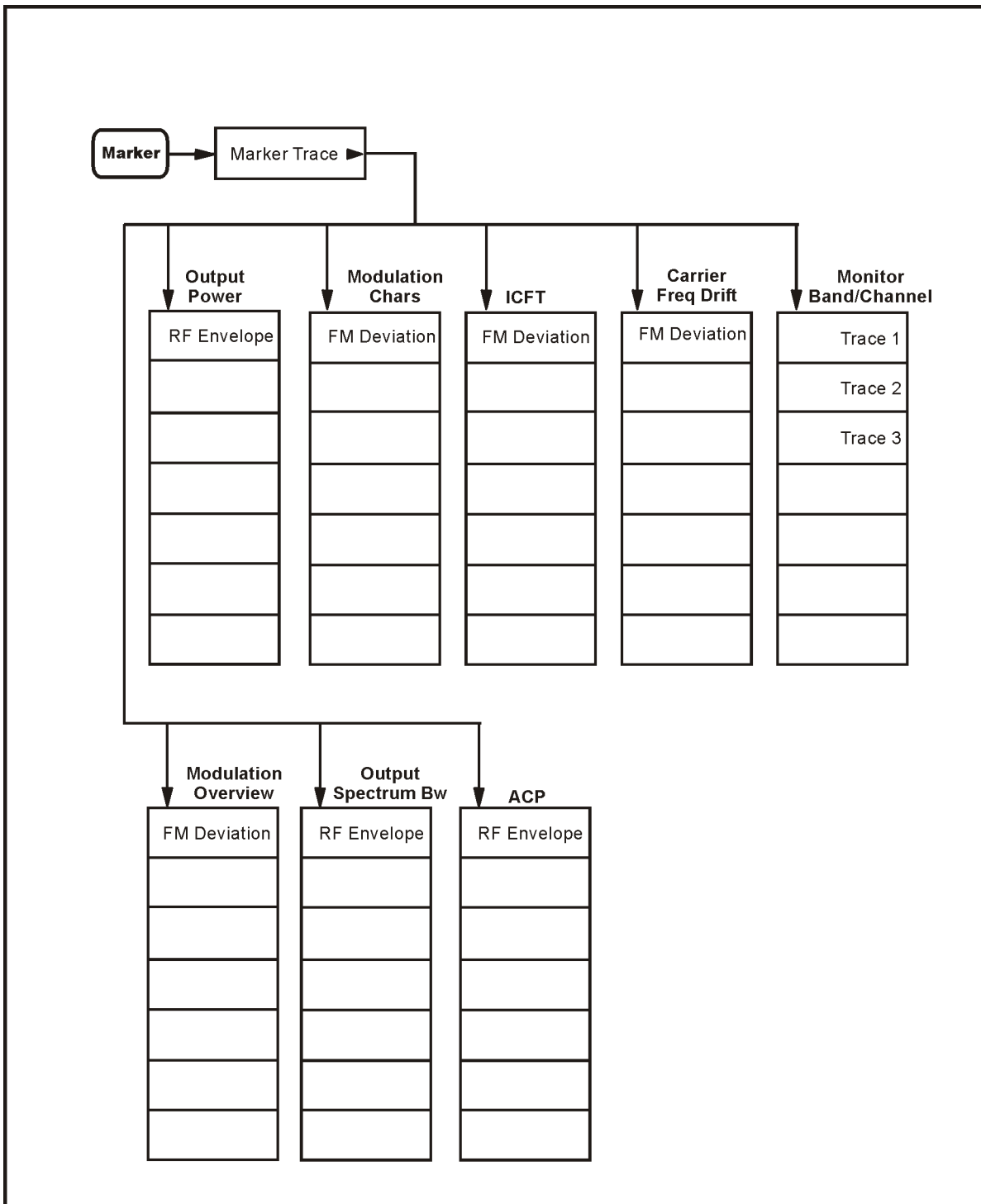

pt813b

MEASURE Menu

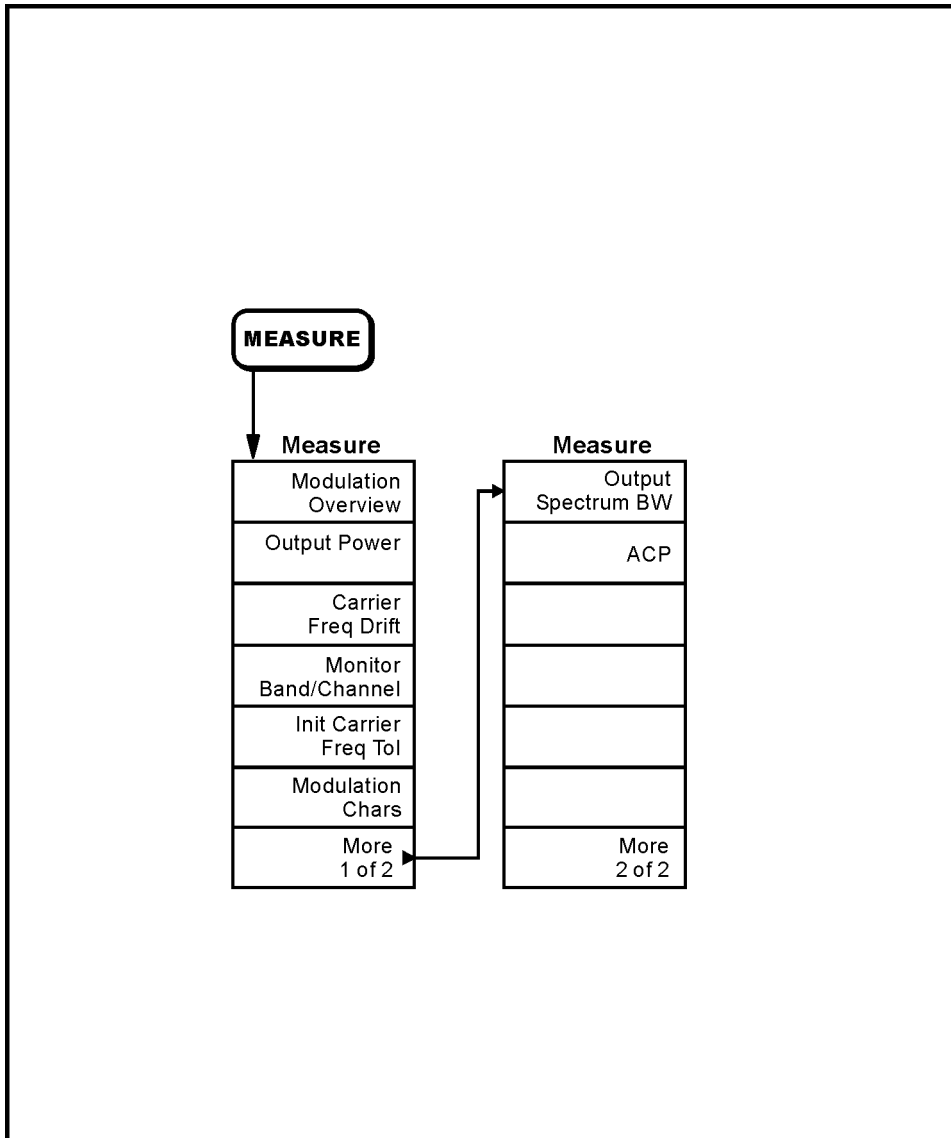

pt85b

Measurement Setup Menus

Modulation Overview Measurement Setup Menu

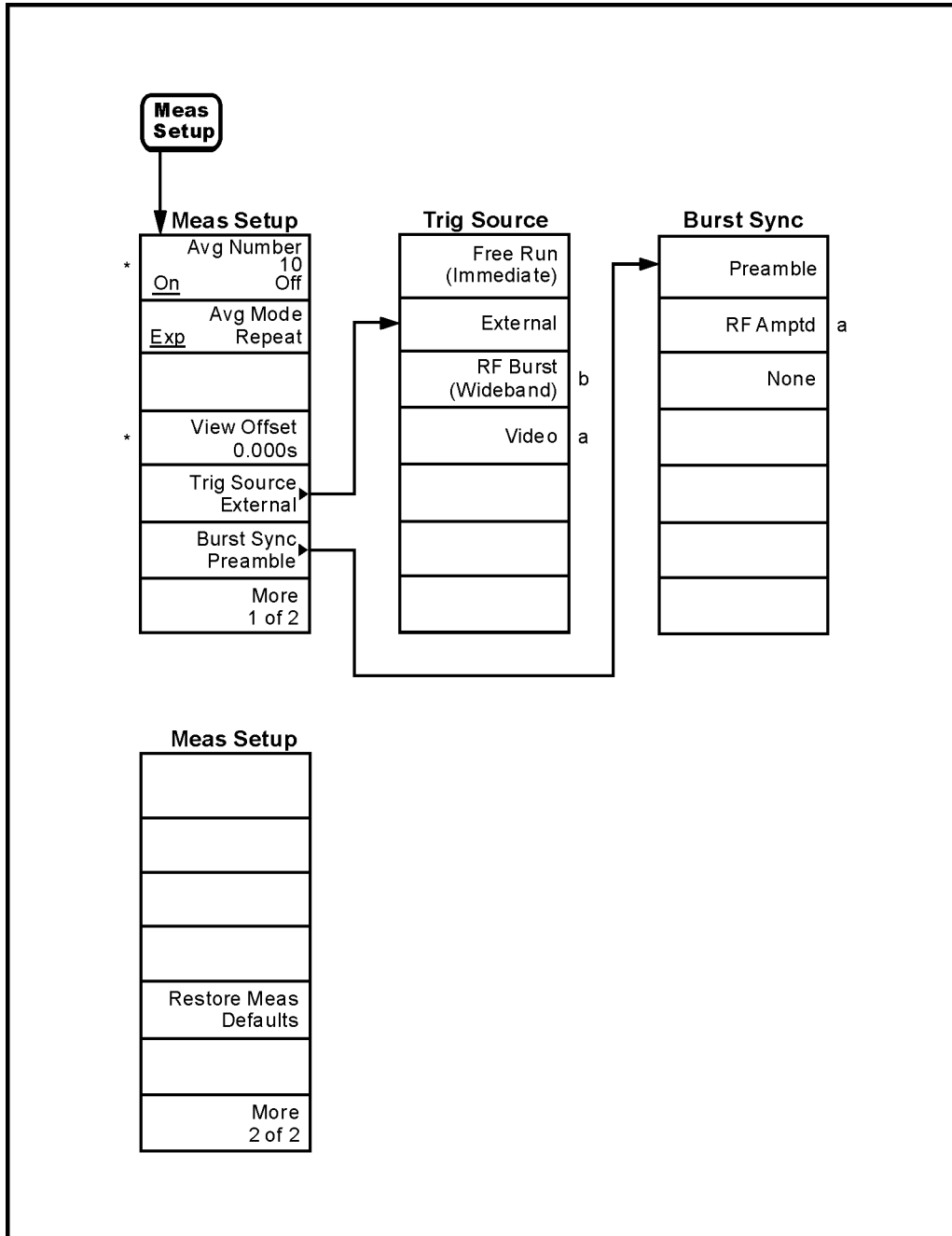

* An active function that allows data entry.

a. Greyed out - not available

b. Requires Option B7E

pt817b

Output Power Measurement Setup Menu

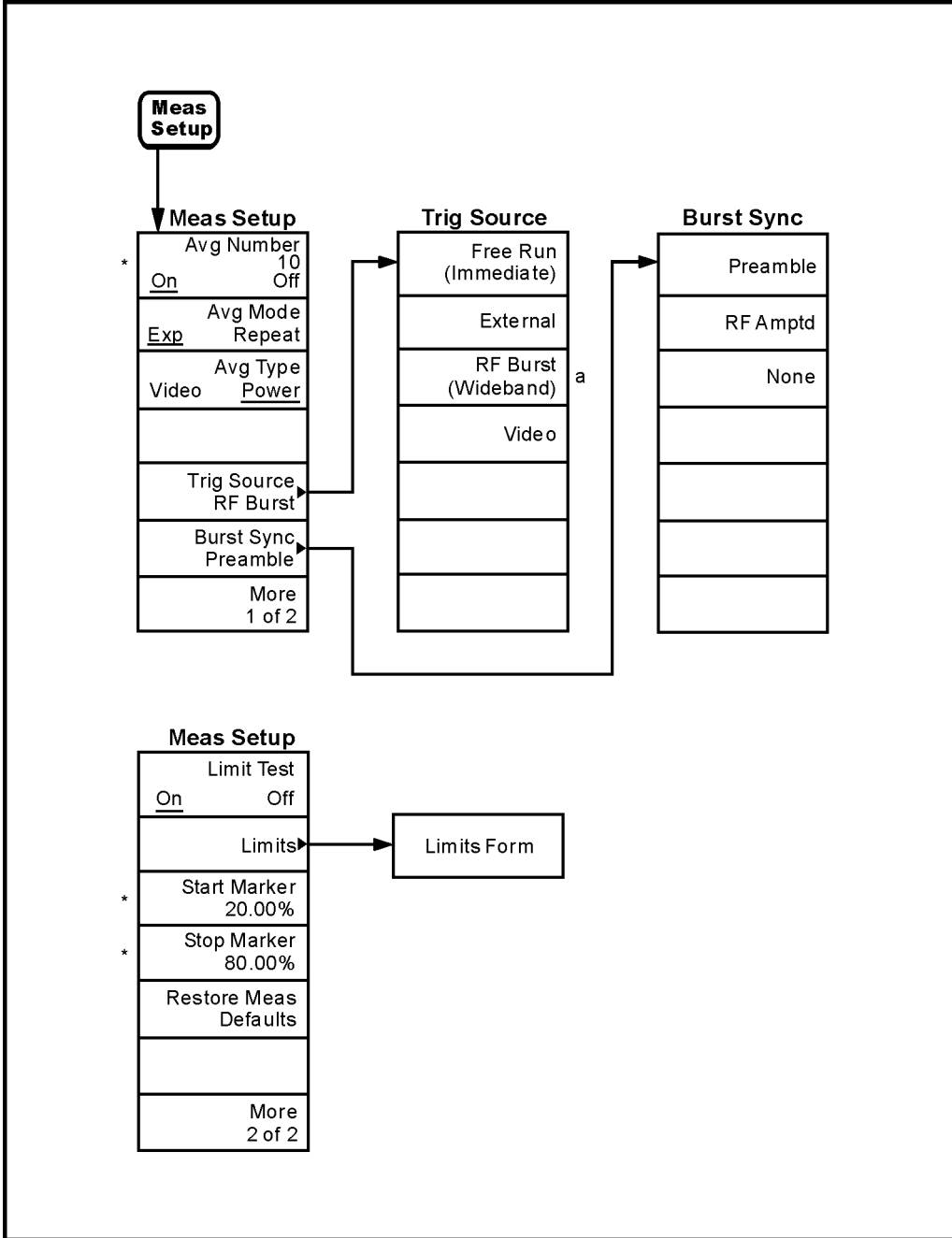

* An active function that allows data entry.
a. Requires Option B7E

Carrier Frequency Drift Measurement Setup Menu

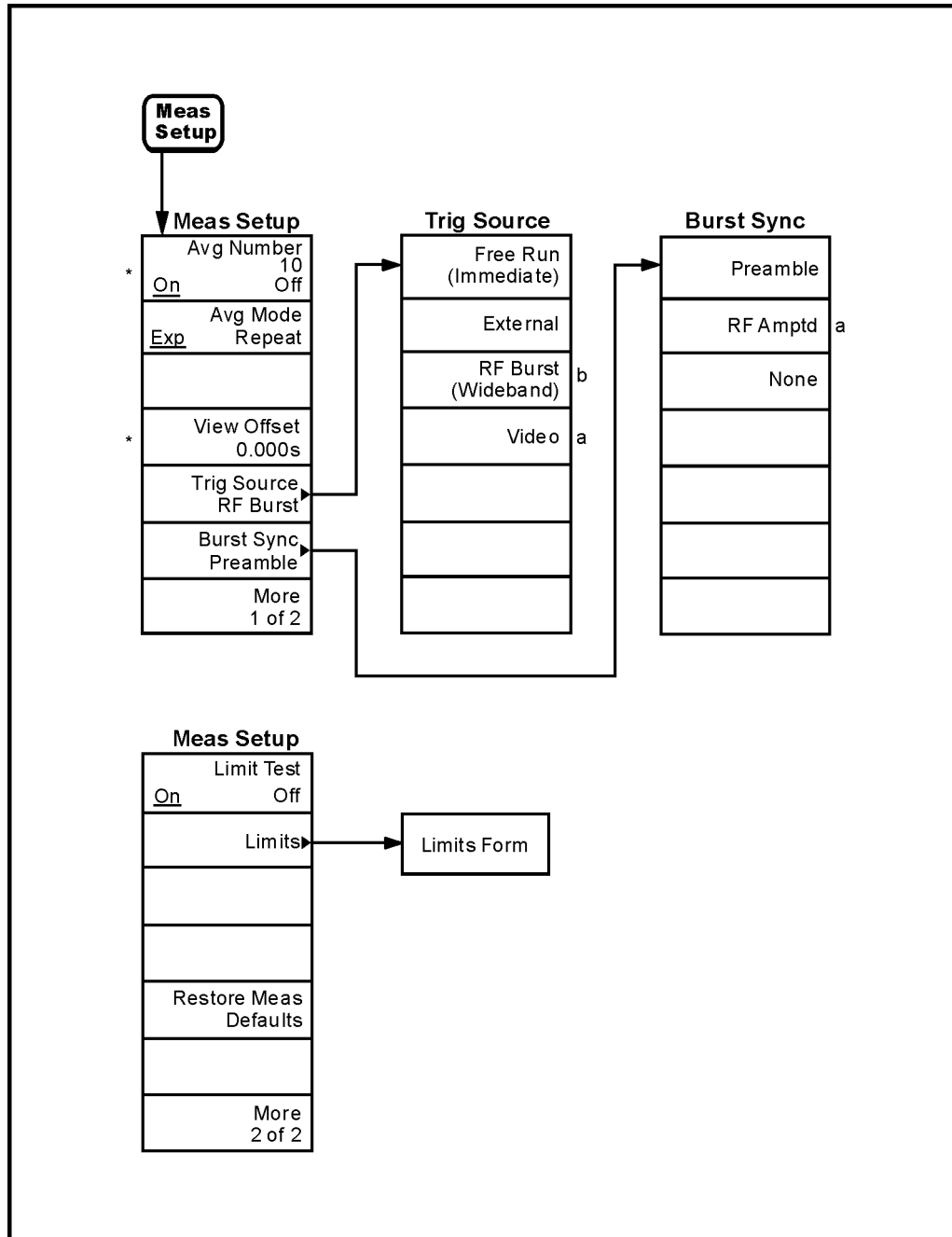

* An active function that allows data entry.
 a. Greyed out- Not available
 b. Requires Option B7E

pt86b

Monitor Band/Channel Measurement Setup Menu

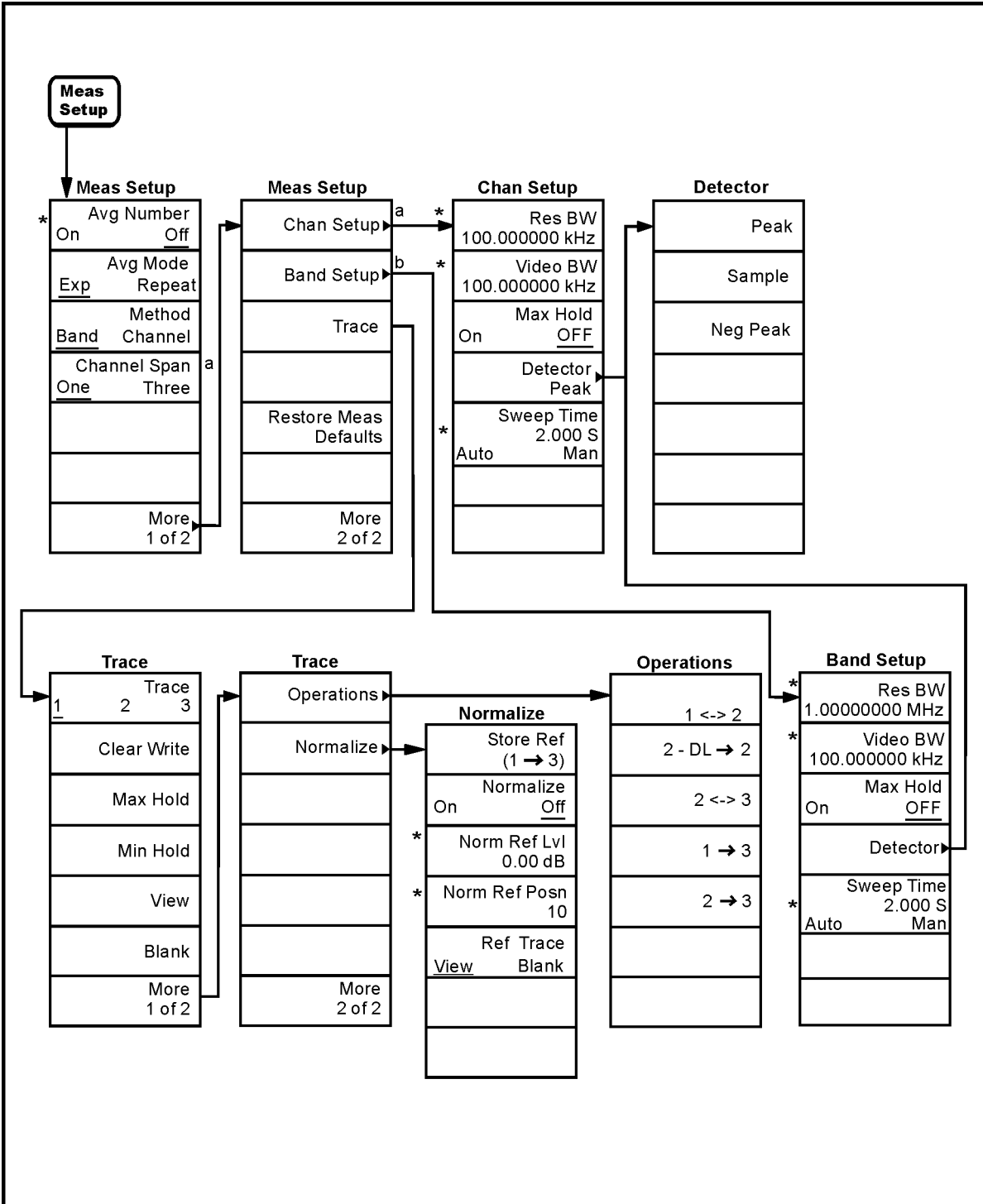

* An active function that allows data entry.
a. If Method is set to **Band** this key is greyed out.
b. If Method is set to **Channel** this key is greyed out.

Initial Carrier Frequency Drift Measurement Setup Menu

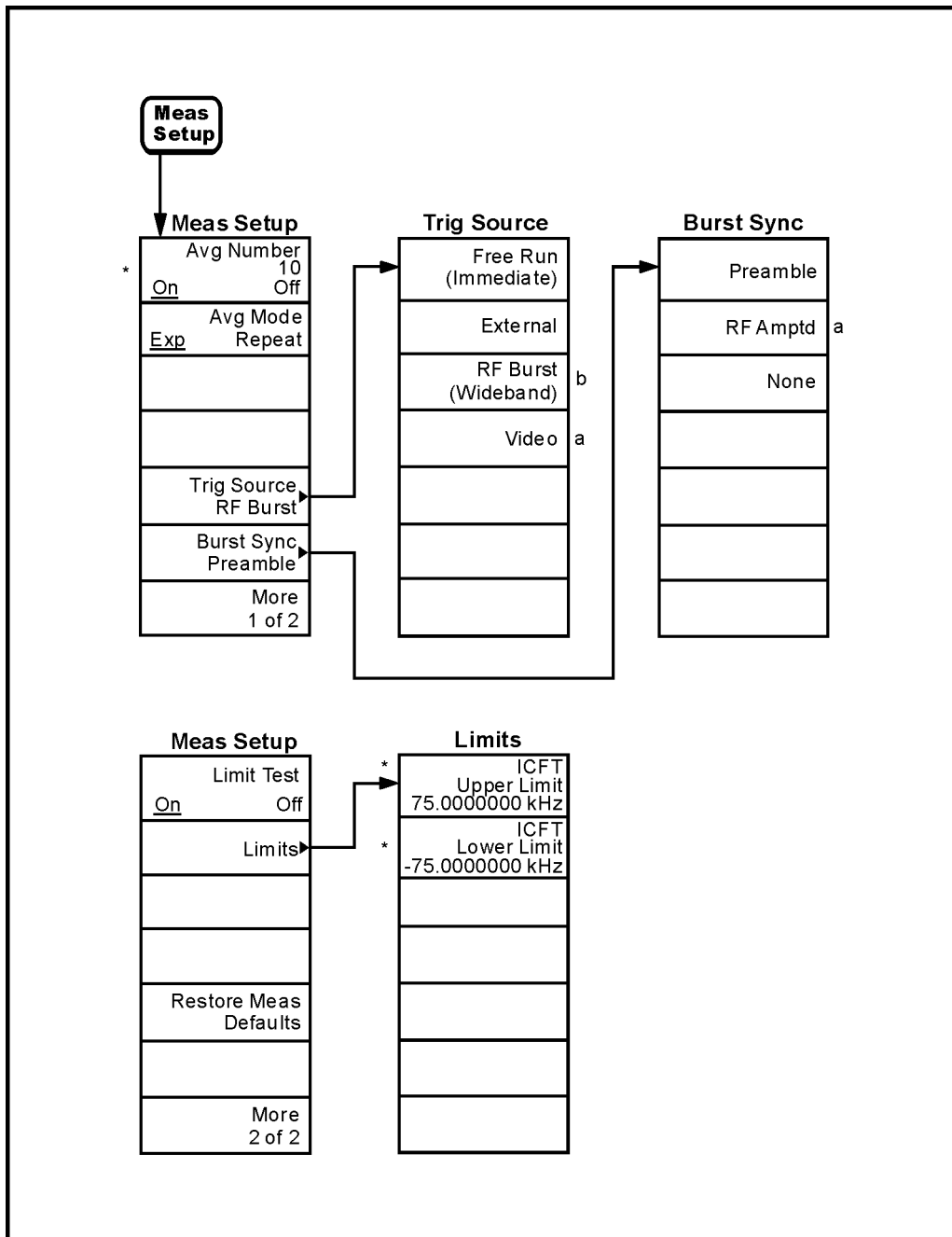

* An active function that allows data entry
a. Greyed out - Not available
b. Requires Option B7E

pt87b

Modulation Characteristics Measurement Setup Menu

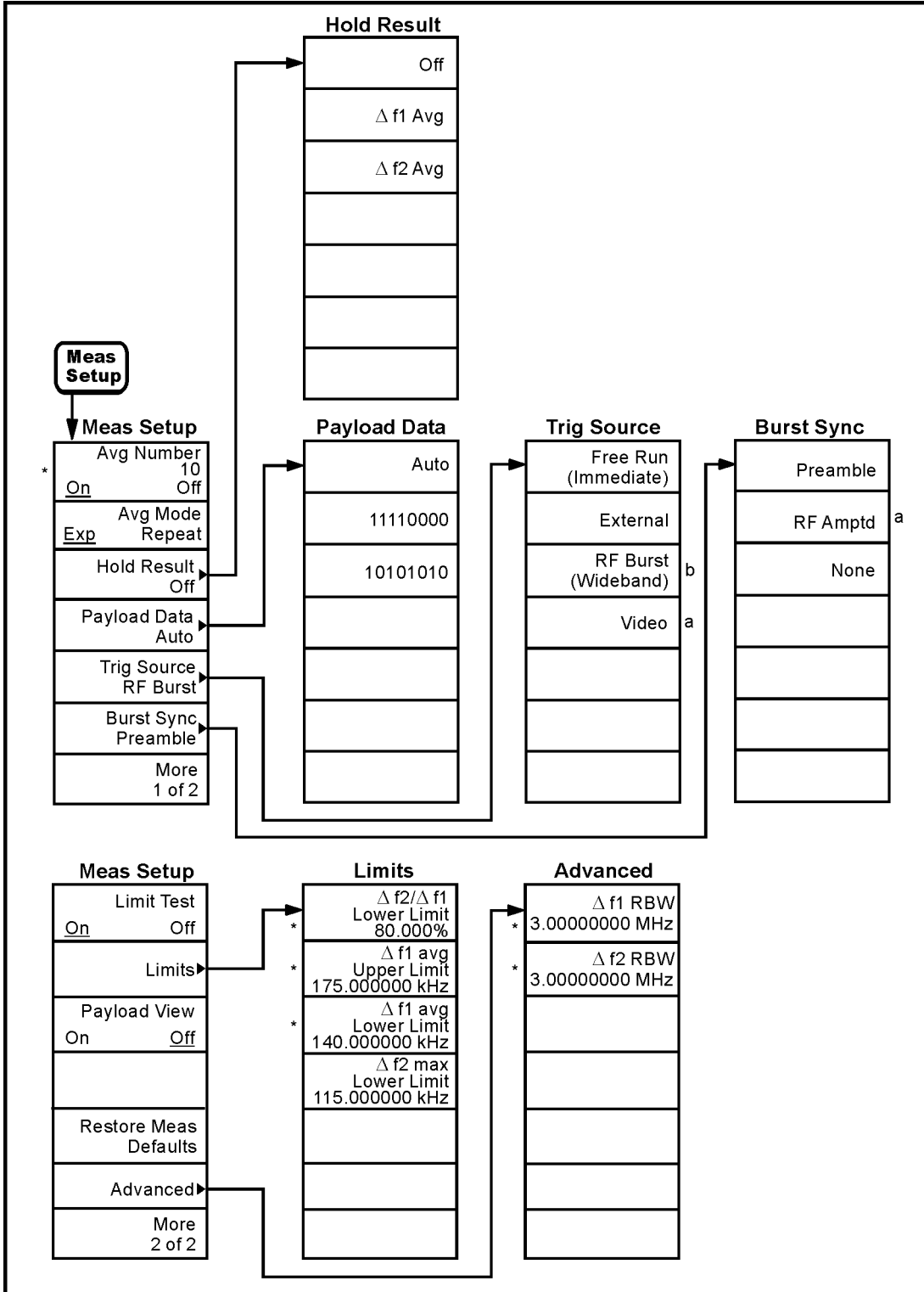

pt88b

Output Spectrum Bandwidth Measurement Setup Menu

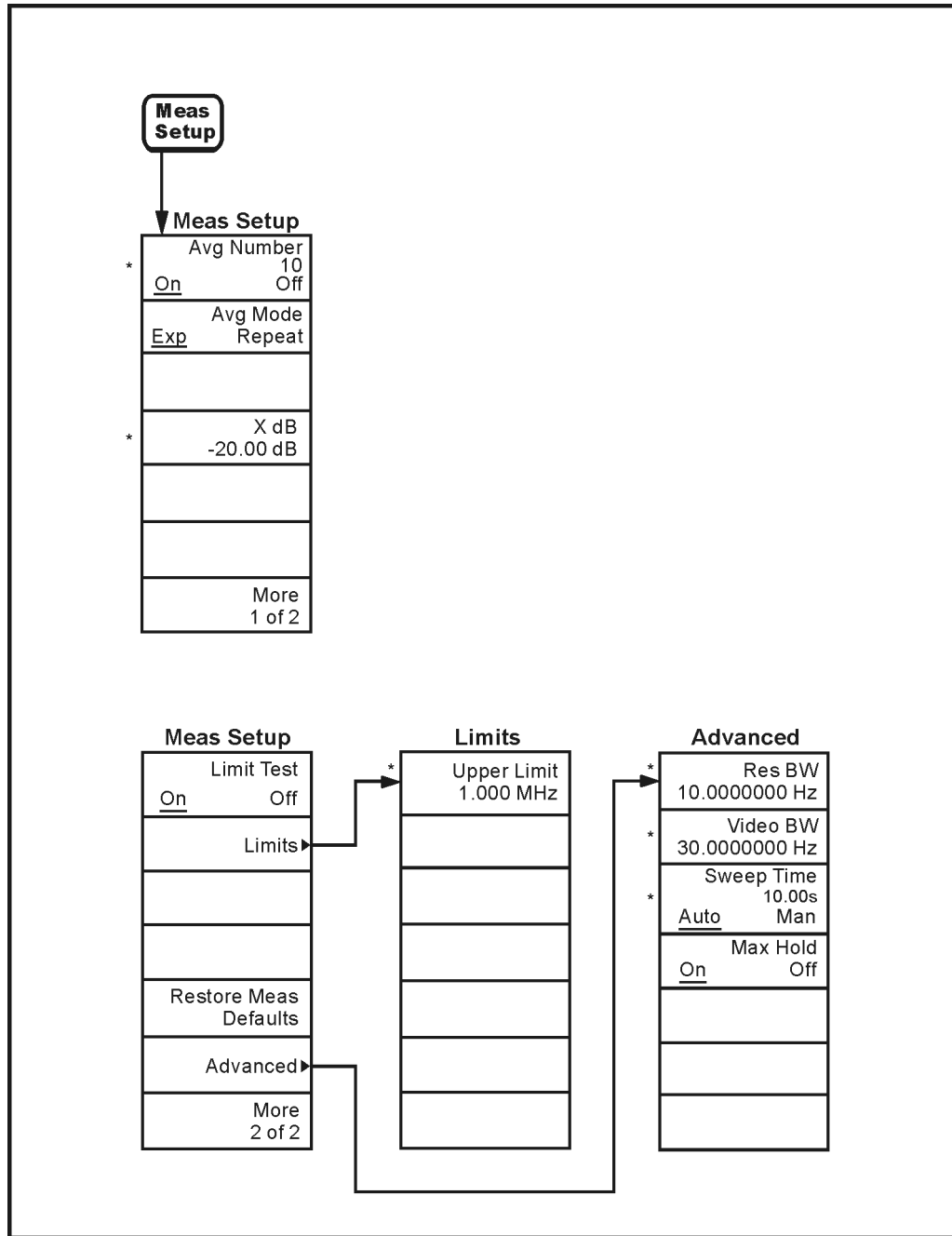

* An active function that allows data entry.

pt818b

ACP Measurement Setup Menu

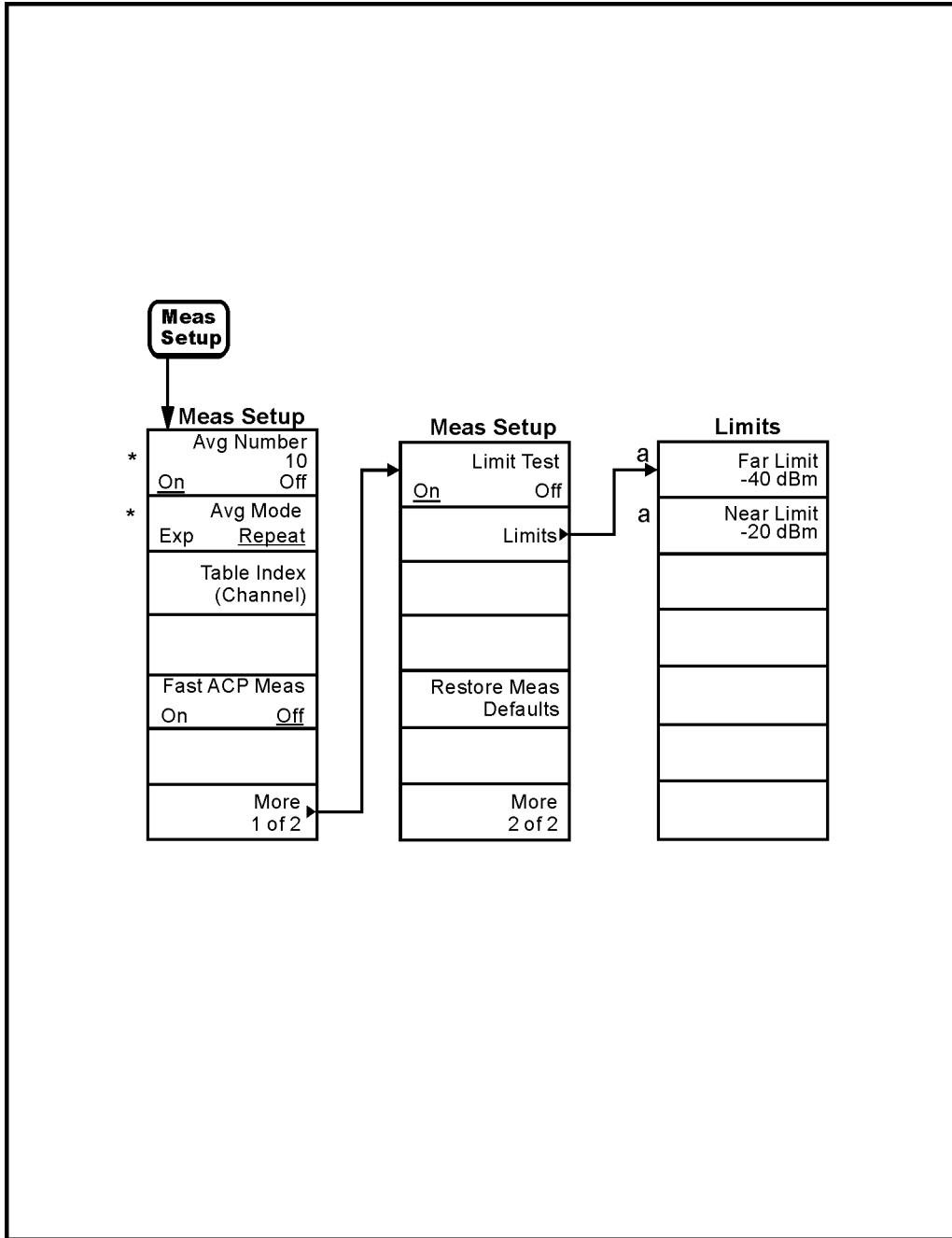

- * If Fast ACP Meas is **on** this key is greyed out.
- a. An active function that allows data entry

pt820b

MODE Menu

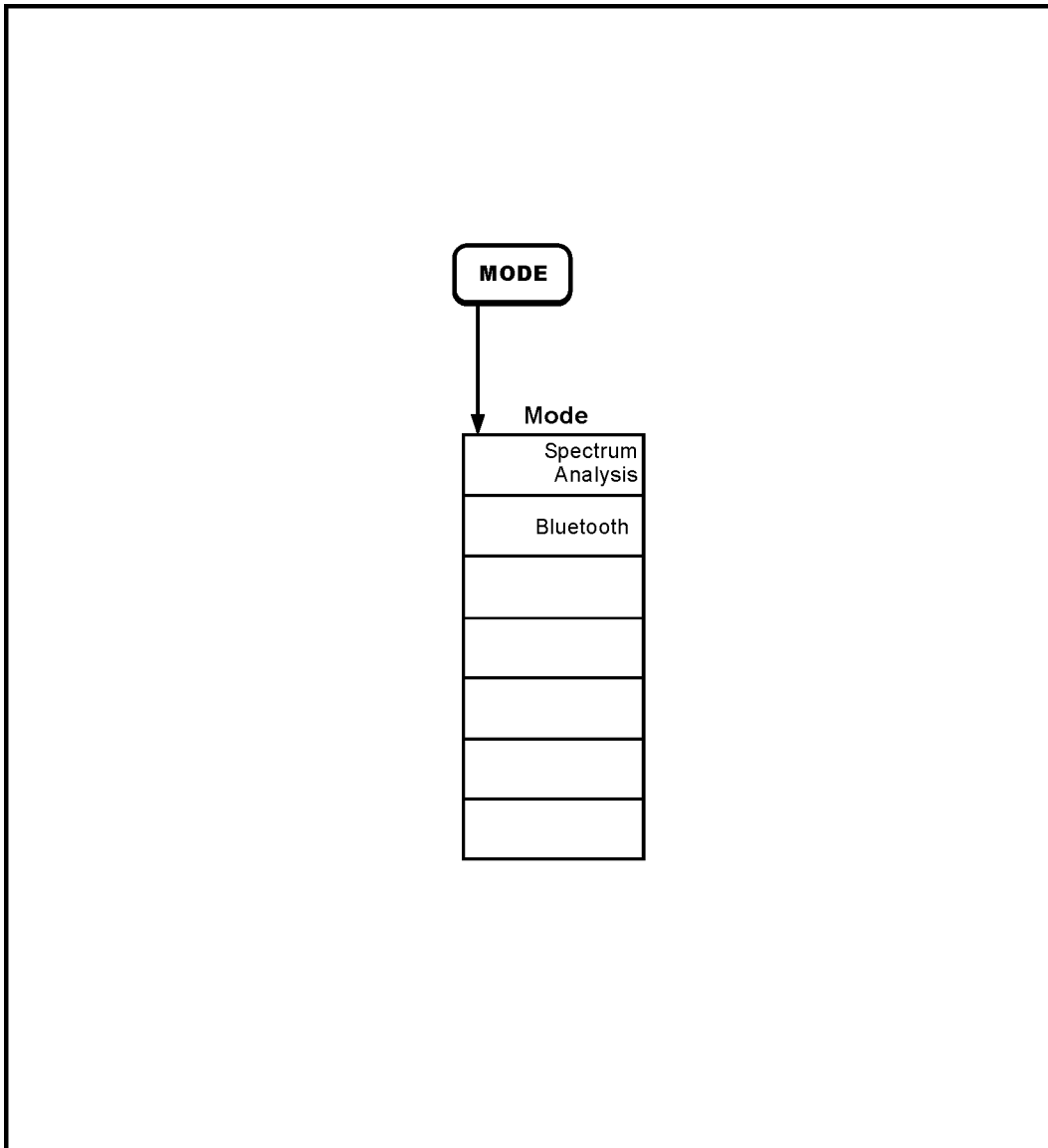

pt811b

Mode Setup Menu

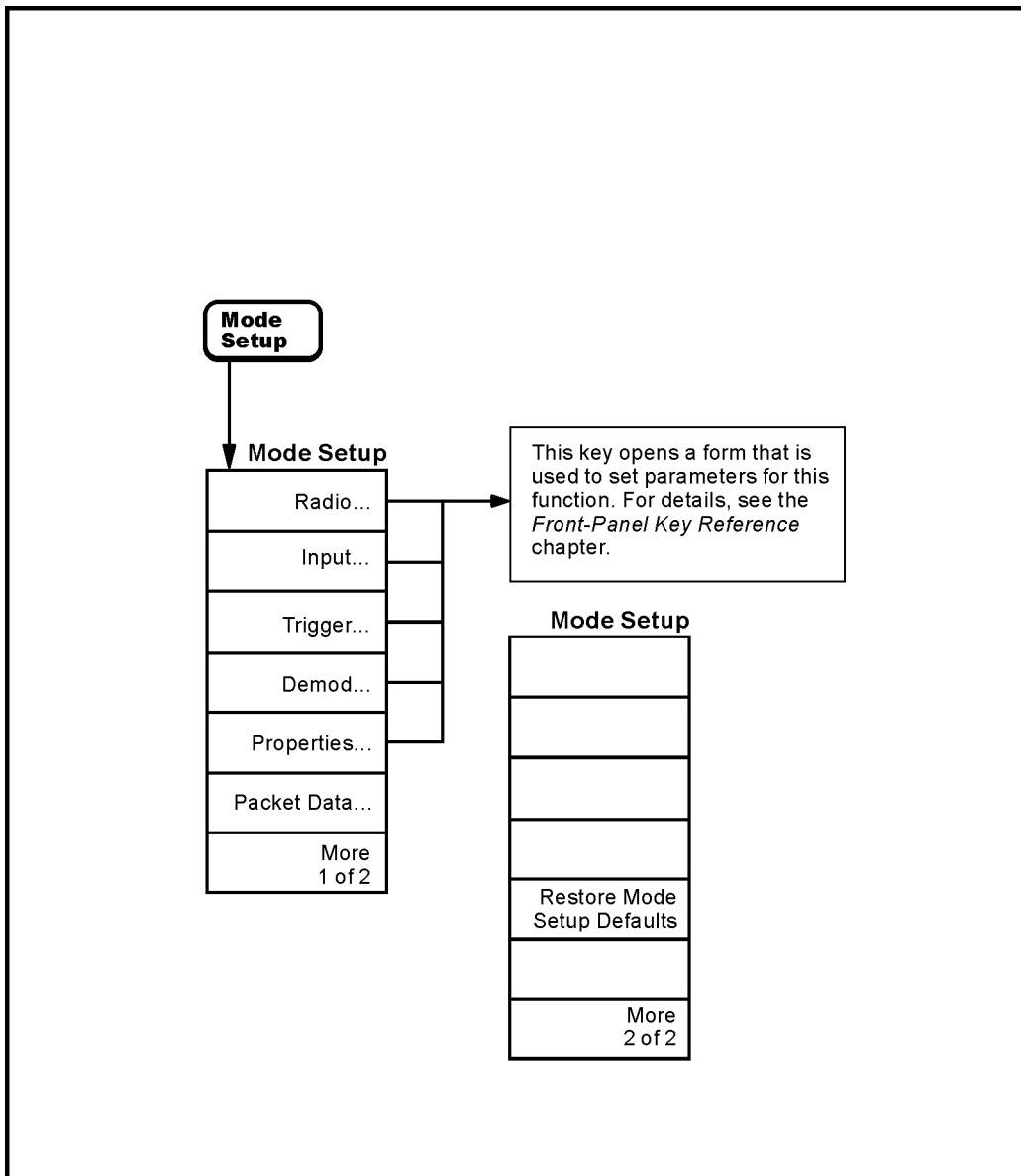

pt812b

Trigger Menu

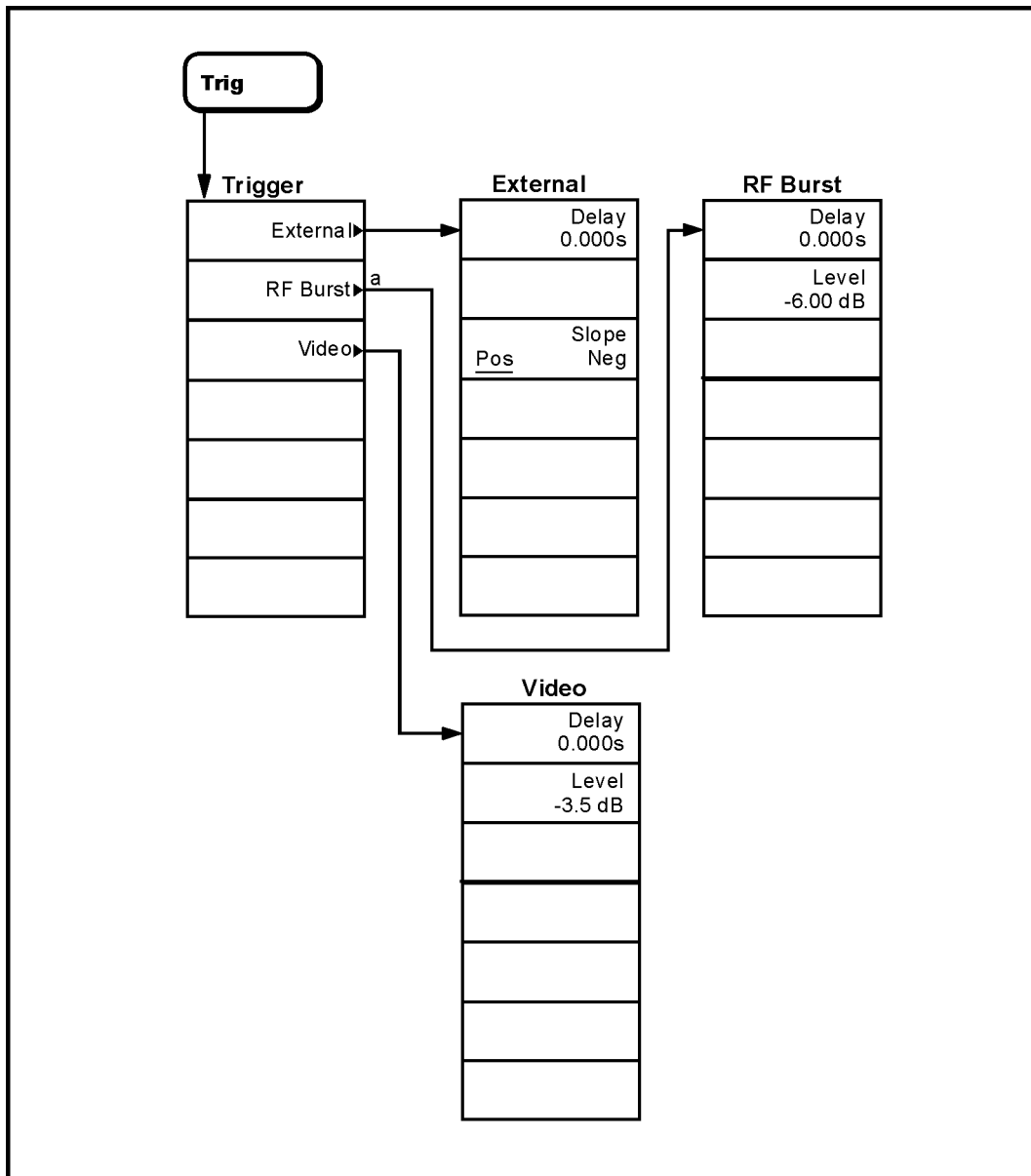

a. Requires Option B7E.

pt814b

View/Trace Menu

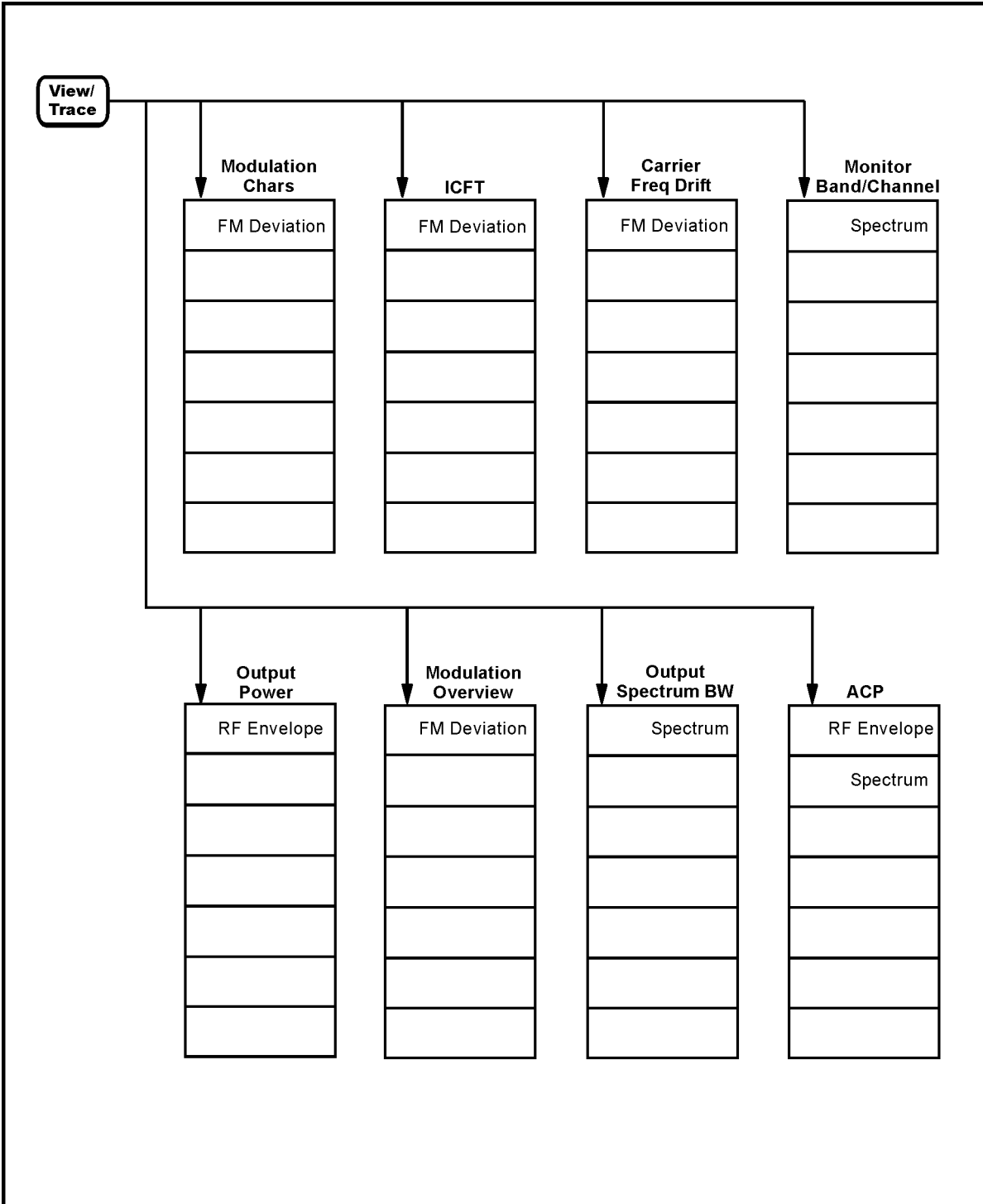

pt815b

5 **Front-Panel Key Reference**

This chapter details the front-panel keys and menu keys that appear on the menu-maps presented in the previous chapter. The front-panel keys are listed alphabetically and are described with their associated menu keys. The menu keys are arranged as they appear on your analyzer menus.

Key Descriptions and Locations

This chapter provides information on the Bluetooth™ personality keys which do not exist in SA mode or have different functionality from SA mode equivalents. For information on SA mode keys not described in this chapter, refer to the *ESA Spectrum Analyzers User's Guide*.

Det/Demod	page 61
Display	page 62
File	page 63
FREQUENCY Channel	page 64
Input/Output	page 66
Marker	page 68
Marker →	page 69
MEASURE	page 70
Measurement Setup—Modulation Overview	page 71
Measurement Setup—Output Power	page 73
Measurement Setup—Carrier Frequency Drift	page 76
Measurement Setup—Monitor Band/Channel	page 79
Measurement Setup—Initial Carrier Frequency Tolerance	page 81
Measurement Setup—Modulation Characteristics	page 83
Measurement Setup—Output Spectrum Bandwidth	page 87
Measurement Setup—ACP	page 89
MODE	page 91
Mode Setup	page 92
Trig	page 94
View/Trace	page 95

Det/Demod

The **Det/Demod** key accesses a menu enabling the following parameters to be changed:

Max Deviation Enter the expected max deviation of the Bluetooth™ modulation. Enter a lower or higher value to match the signal if the measurement has trouble detecting the preamble (bit p0) position.

Burst Search Threshold Enter the value, relative to the average power, that should be used to determine the start and end points of the initial burst duration.

Burst Search Pre-Trigger Enter the value, relative to the trigger, that will determine the point where the trace data will start to be collected.

Default Settings

The following table shows the default settings for the Demod menu.

Det/Demod Default Settings	
Max Deviation	157 kHz
Burst Search Threshold	-3.00 dB
Burst Search Pre-Trigger	-100 μs

Display

The **Display** front panel key leads to one of the Bluetooth™ measurement display menus, depending on which measurement is selected when the key is pressed.

Title For each measurement, pressing the **Title** key leads to a menu enabling the title string to be changed or cleared.

Preferences For each measurement, pressing the **Preferences** key leads to a menu enabling the graph window graticule or annotation to be turned on/off.

Additional Display Keys

Monitor Band/Channel

Display Line Turns on/off an adjustable horizontal line that is used as a visual reference line.

On Displays the line.

Off Turns off the line.

The default value is Off.

File

The functions accessed by the **File** key are identical to those accessed in SA mode, with the addition of a new file type, **Measurement Results**.

For further information on the File functions, refer to the Agilent ESA Spectrum Analyzers User's Guide.

Measurement Results

Allows you to save the measurement results in a .csv (comma separated values) format, suitable for opening in a spreadsheet program on a personal computer/laptop/palmtop.

FREQUENCY Channel

The **FREQUENCY Channel** front panel key provides access to menu keys which control the center frequency or channel number to be used for measurements. These parameters apply to all measurements in the current mode.

For most measurements, changing the **Channel** or **Center Freq** will immediately change the analyzer center frequency.

The exception is the Monitor Band/Channel measurement. In this measurement, if **Method** is set to **Band**, changing the **Channel** or **Center Freq** does not affect the current center frequency. The center frequency value will not be updated until the next measurement is selected. If **Method** is set to **Channel**, the center frequency is changed as per the other measurements.

Channel	Used to enter the channel to be measured. It is coupled with Center Freq —setting Channel sets the center frequency to the value corresponding to that channel. Screen displays show the center frequency displayed in the graph window and the channel displayed on the Measurement Bar. Note that changing the channel tunes the analyzer to the relevant center frequency and restarts the measurement.
Center Freq	Sets the center frequency to be measured. It is coupled with Channel —setting Center Freq also sets Channel to the channel corresponding to that frequency. If the center frequency value entered does not exactly correlate with a channel, the softkey label and Measurement Bar change to display the closest channel to the selected frequency. It also displays a > or < symbol indicating whether the frequency is above or below that channel.
L M H Channel	Enables quick selection from a subset of the available channel numbers for the Low (channel 0), Middle (channel 39), or High (channel 78) channels.
Packet Type	Allows you to select the desired packet type to measure. Different packets have different properties, and the measurement algorithms will adjust parameters depending on the type of packet selected.
Auto Channel	When you activate this key the channel will be set to the channel nearest to the strongest signal within the Bluetooth™ operating frequencies. No validation of the signal is conducted.

Default Settings

The following table shows the default settings for the Frequency Channel menu.

FREQUENCY Channel Default Settings	
Channel	0
Center Freq	2.40200 GHz
L M H Channel	N/A
Packet Type	DH1

Input/Output

RF Input Range	Possible values are Auto and Man . If Auto is chosen, the instrument automatically sets the attenuator and reference level based on the total power level of the input signal carrier. If there are multiple carriers present, the total power might overdrive the front end. In this case, you need to set the RF Input Range to Man and enter the expected Max Total Pwr . Man is also used if you want to hold the input attenuation constant (for the best relative power accuracy). For single carriers, it is generally recommended that RF Input Range is set to Auto .
Max Total Pwr	<p>To set the maximum total power at the UUT (Unit Under Test). This is the maximum expected value of the total power referenced to the output of the UUT (may include multiple carriers). The Max Total Power setting is coupled to the Input Atten setting.</p> <p>When RF Input Range is set to Auto, the Max Total Power is set to the measured single carrier power and the displayed value updated at the start of each Bluetooth™ measurement. If you change Max Total Power, the value will be used and RF Input Range will be changed to Man.</p> <p>When RF Input Range is set to Man, the current value of Max Total Power is used directly to calculate the Input Atten required to ensure a safe/optimum level at the input to the first mixer. It is still necessary to ensure the actual signal power present at the input to the measurement setup does not exceed the stated Max Total Power.</p>
Input Atten	<p>To set the input attenuator setting. The input attenuator setting is coupled to the Max Total Power setting. The Input Atten key reads out the actual internal input attenuator value that will be used for the current measurement.</p> <p>When RF Input Range is set to Auto, the Input Atten value is calculated based on the measured Max Total Power value and updated at the start of each Bluetooth™ measurement. If you change Input Atten, the value will be used and RF Input Range will be changed to Man.</p>
NOTE	As the Max Total Pwr and Input Atten settings are coupled together, changing the input Max Total Pwr by x dB changes the Input Atten by x dB, and vice-versa, for a given measurement. When you switch to a different measurement, the Max Total Pwr is kept constant, but the Input Atten may change, if the two measurements have different mixer margins. Thus, you can directly set the analyzer input attenuation, or you can set it indirectly by specifying the maximum expected power at the UUT (Max Total Pwr setting).
Int Preamp	Used to control the analyzer's in-built preamplifier for better sensitivity. Possible values are Off and On .
Ext Gain	Used to enter the external gain setting for any devices between the UUT and the analyzer. This enables the instrument to display the measurement results referenced to the output of the UUT.

Ext Atten

Used to enter the external attenuator setting for any devices between the UUT and the analyzer. This enables the instrument to display the measurement results referenced to the output of the UUT.

Default Settings

The following table shows the default settings for the Input menu.

Input Default Settings	
RF Input Range	Auto
Max Total Power	-15 dBm
Input Attenuation	5 dB
Internal Preamp	Off
External Gain	0.00 dB
External Attenuation	0.00 dB

Marker

The functions accessed by the Marker key are identical to those accessed in SA mode, with the exception of the **Marker Trace** key. For further information refer to the *Agilent ESA Spectrum Analyzers User's Guide*.

Marker Trace

Either activates a marker on trace 1 or accesses a menu that allows you to assign a marker to a trace. The menu displayed is dependent on the measurement selected under the **MEASUREMENT** key.

Monitor Band/Channel

Pressing **Marker Trace** when in the Monitor Band/Channel measurement will bring up a Marker Trace menu with three menu items, **Trace 1**, **Trace 2**, and **Trace 3**. Pressing any of these keys will activate a marker on the indicated trace if there are no markers turned on. If a marker is currently active, the active marker will be moved to the selected trace.

Key Access: **Marker**, **More**, **Marker Trace**

Output Power, Output Spectrum, and Adjacent Channel Power

Pressing **Marker** when in either the Output Power, Output Spectrum, or Adjacent Channel Power measurement activates a marker on trace 1.

Pressing **Marker Trace** will bring up a Marker Trace menu with a single menu item, **RF Envelope**.

Key Access: **Marker**, **More**, **Marker Trace**

Modulation Characteristic, Initial Carrier Frequency Tolerance, Carrier Frequency Drift, and Modulation Overview

Pressing **Marker** when in either the Modulation Characteristic, Initial Carrier Frequency Tolerance, Carrier Frequency Drift, or Modulation Overview measurement activates a marker on trace 1.

Pressing **Marker Trace** will bring up a Marker Trace menu with a single menu item, **FM Deviation**.

Key Access: **Marker**, **More**, **Marker Trace**

Marker →

Accesses the following marker function menu keys:

Mkr → **CF**

Sets the center frequency of the analyzer to the marker frequency. In Delta mode, Mkr → CF sets the center frequency to the marker delta value. Mkr → CF is not available in zero span.

Key Access: **Marker** →

Mkr → **Chan**

Sets the channel number of the analyzer to the nearest channel number corresponding to the marker frequency. Mkr → Chan is not available in zero span.

Key Access: **Marker** →

MEASURE

The MEASURE front panel key provides access to menu keys which enable you to make the following ESA-E Series Spectrum Analyzer Bluetooth™ measurements:

- Modulation Overview
- Output Power
- Carrier Frequency Drift
- Monitor Band/Channel
- Initial Carrier Frequency Tolerance
- Modulation Characteristics
- Output Spectrum Bandwidth
- Adjacent Channel Power (ACP)

Meas Setup

The **Meas Setup** front panel key displays a menu that allows you to enter custom setup parameters for a measurement. The setup menu displayed depends on the measurement selected from the **MEASURE** menu.

Modulation Overview (MOV)

To access the keys for setting up a modulation overview measurement, press **MEASURE**, **Modulation Overview**, and then the front panel **Meas Setup** key.

Avg Number Used to specify the number of data acquisitions that will be averaged. After the specified number of average counts, the averaging mode (terminal control) setting determines the averaging action.

On Sets measurement averaging on.

Off Sets measurement averaging off.

Front Panel default is Off.

Avg Mode Used to select the type of termination control for the averaging function. This determines the averaging action after the specified number of data acquisitions (average count) is reached.

Exp After the average count is reached, each successive data acquisition is exponentially weighted and combined with the existing average.

Repeat After reaching the average count, the averaging is reset and a new average is started.

The default value is Exp.

View Offset This parameter is used to offset the trace displayed on the screen. Although a restart is witnessed on changing this parameter it is not a full restart and only changes the trace position on the screen, not the results being calculated. When view offset is adjusted, a second marker is displayed to indicate the offset point relative to bit p0.

Trig Source Used to select the trigger source for the measurement. Possible values are Free Run, External, and RF Burst (Option B7E required).

The default value is RF Burst. If the analyzer does not have Option B7E installed, the default will be External.

Meas Setup

Burst Sync

Used to select how the measurement will synchronize with the correct part of the burst. Possible values are Preamble and None. Preamble uses p0 to define the start of the burst. When Burst Sync is set to preamble, a white marker indicates “bit0” in the preamble of the trace. If the “bit0” marker is off screen due to a large view offset, a label with an arrow will appear to the right or left edge of the screen indicating where “bit0” is located.

The default value is Preamble.

Restore Meas Defaults

Restores all **Meas Setup** parameter values for the current measurement to their factory defaults.

Default Settings

The following table shows the default settings for the Modulation Overview measurement.

Parameter	Default	Min	Max
		or Selections	
Avg Number	Off	0	1000
Avg Mode	Exp	Exp, Repeat	
View Offset	0.000s	-4s	4s
Trig Source	RF Burst ^a	Free Run, RF Burst, External	
Burst Sync	Preamble	Preamble, None	

a. External if Option B7E is not installed.

Output Power (OPOW)

To access the keys for setting up an output power measurement, press **MEASURE**, **Output Power**, and then the front panel **Meas Setup** key.

Avg Number Used to specify the number of data acquisitions that will be averaged. After the specified number of average counts, the averaging mode (terminal control) setting determines the averaging action.

On Sets measurement averaging on.

Off Sets measurement averaging off.

Front Panel default is Off.

Avg Mode Used to select the type of termination control for the averaging function. This determines the averaging action after the specified number of data acquisitions (average count) is reached.

Exp After the average count is reached, each successive data acquisition is exponentially weighted and combined with the existing average.

Repeat After reaching the average count, the averaging is reset and a new average is started.

The default value is Exp.

Avg Type Used to select the type of averaging between video and power averaging.

Video Video uses linear averaging.

Power Power uses logarithmic averaging.

The default value is Power.

Trig Source Used to select the trigger source for the measurement. Possible values are Free Run, External, RF Burst (Option B7E required), and Video.

The default value is RF Burst. If the analyzer does not have Option B7E installed, the default will be External.

Burst Sync Used to select how the measurement will synchronize with the correct part of the burst. Valid choices are Preamble, RF Amptd and None. Preamble uses p0 to define the start of the burst. RF Amptd defines the duration of the burst as the time between the leading and trailing 3 dB points compared to the average power.

The default value is Preamble.

Front-Panel Key Reference

Meas Setup

Limit Test	<p>Turns limit checking on and off. This is not the same as limit lines – the numeric peak and average power results are checked against the Peak Upper Limit, Avg Upper Limit and Avg Lower Limit parameters to see if they meet the limit requirements. The relevant PASS/FAIL annotation is displayed in the measurement bar.</p> <p>The default value is On.</p>
Limits....	<p>Accesses the limits form to change the limits <i>for the currently selected power class</i>. The measurement is restarted if any limits value is changed.</p> <p>Peak Power Upper Limit The Peak Power must be less than or equal to this limit. If the Peak Power is greater than this limit, the measurement display will append a red “F” to the value. This limit is set depending on the currently selected Power Class.</p> <p>Average Power Upper Limit The Avg Power must be less than or equal to this limit. If the Avg Power is greater than this limit, the measurement display will append a red “F” to the value. This limit is set depending on the currently selected Power Class.</p> <p>Average Power Lower Limit The Avg Power must be greater than or equal to this limit. If the Avg Power is less than this limit, the measurement display will append a red “F” to the value. If the currently selected Power Class is 3, this parameter is not required and therefore will not be shown on the form. Otherwise this limit is set depending on the currently selected Power Class.</p>
Start Marker	<p>This parameter is used to determine the point at which averaging of the power should begin. It is defined as a percentage of the burst length. The difference between the stop and start marker must be at least 1%.</p>
Stop Marker	<p>This parameter is used to determine the point at which averaging of the power should stop. It is defined as a percentage of the burst length. The difference between the stop and start marker must be at least 1%.</p>
Restore Meas Defaults	<p>Restores all Meas Setup parameter values for the current measurement to their factory defaults.</p>

Default Settings

The following table shows the default settings for the Output Power measurement.

Parameter	Default	Min	Max
		or Selections	
Avg Number	Off	0	1000
Avg Mode	Exp	Exp, Repeat	
Average Type	Power	Video, Power	
Trig Source	RF Burst ^a	Free Run, RF Burst, External, Video	
Burst Sync	Preamble	Preamble, RF Amptd, None	
Start Marker	20.00%	0.00%	99.00%
Stop Marker	80.00%	1.00%	100.00%
Peak Power Upper Limit	23.00 dBm	-100.00 dBm	30.00 dBm
Avg Power Upper Limit	Pwr Class 1 20.00 dBm Pwr Class 2 4.00 dBm Pwr Class 3 0.00 dBm	-100.00 dBm	30.00 dBm
Avg Power Lower Limit	Pwr Class 1 0.00 dBm Pwr Class 2 -6.00 dBm Pwr Class 3 N/A	-100.00 dBm	30.00 dBm

a. External if Option B7E is not installed.

Carrier Frequency Drift (CFDR)

To access the keys for setting up a carrier frequency drift measurement, press **MEASURE**, **Carrier Freq Drift**, and then the front panel **Meas Setup** key.

Avg Number Used to specify the number of data acquisitions that will be averaged. After the specified number of average counts, the averaging mode (terminal control) setting determines the averaging action.

On Sets measurement averaging on.

Off Sets measurement averaging off.

Front Panel default is Off.

Avg Mode Used to select the type of termination control for the averaging function. This determines the averaging action after the specified number of data acquisitions (average count) is reached.

Exp After the average count is reached, each successive data acquisition is exponentially weighted and combined with the existing average.

Repeat After reaching the average count, the averaging is reset and a new average is started.

The default value is Exp.

View Offset This parameter is used to offset the trace displayed on the screen. Although a restart is witnessed on changing this parameter, it is not a full restart and only changes the trace position on the screen not the results being calculated. When view offset is adjusted, a second marker is displayed to indicate the offset point relative to bit p0.

Trig Source Used to select the trigger source for the measurement. Possible values are Free Run, External, and RF Burst (Option B7E required).

The default value is RF Burst. If the analyzer does not have Option B7E installed, the default will be External.

Burst Sync Used to select how the measurement will synchronize with the correct part of the burst. Valid choices are Preamble and None. Preamble uses p0 to define the start of the burst. When Burst Sync is set to preamble, a white marker indicates “bit0” in the preamble of the trace. If the “bit0” marker is off screen due to a large view offset, a label with an arrow will appear to the right or left edge of the screen indicating where “bit0” is located.

The default value is Preamble.

Limit Test	<p>Turns limit checking on and off. This is not the same as limit lines – the numeric Max Drift Rate and Freq Drift results are checked against the Maximum Drift Rate Upper and Lower Limit and the Freq Drift Upper and Lower Limit parameters to see if they meet the limit requirements. The relevant PASS/FAIL annotation is displayed in the measurement bar.</p> <p>The default value is On.</p>
Limits....	<p>Accesses the limits form to change the limits <i>for the currently selected packet type</i>. The measurement is restarted if any limits value is changed.</p> <p>Max Drift Rate Upper Limit The Max Drift Rate must be less than or equal to this limit. If the Max Drift Rate is greater than this limit, the measurement display will append a red “F” to the value.</p> <p>Max Drift Rate Lower Limit The Max Drift Rate must be greater than or equal to this limit. If the Max Drift Rate is less than this limit, the measurement display will append a red “F” to the value.</p> <p>Freq Drift Upper Limit The Freq Drift must be less than or equal to this limit. If the Freq Drift is greater than this limit, the measurement display will append a red “F” to the value. This limit is set depending on the currently selected Packet Type.</p> <p>Freq Drift Lower Limit The Freq Drift must be more than or equal to this limit. If the Freq Drift is less than this limit, the measurement display will append a red “F” to the value. This limit is set depending on the currently selected Packet Type.</p>
Restore Meas Defaults	<p>Restores all Meas Setup parameter values for the current measurement to their factory defaults.</p>

Default Settings

The following table shows the default settings for the Carrier Frequency Drift measurement.

Parameter	Default	Min	Max
		or Selections	
Avg Number	Off	0	1000
Avg Mode	Exp	Exp, Repeat	
Trig Source	RF Burst ^a	Free Run, RF Burst, External	
Burst Sync	Preamble	Preamble, None	
View Offset	0.00s	-4.00s	4.00s
Max Drift Rate Upper Limit	20 kHz	-500 kHz	500 kHz
Max Drift Rate Lower Limit	-20 kHz	-500 kHz	500 kHz
Freq Drift Upper Limit	DH1 Packet 25 kHz DH3 Packet 40 kHz DH5 Packet 40 kHz	-500 kHz	500 kHz
Freq Drift Lower Limit	DH1 Packet -25 kHz DH3 Packet -40 kHz DH5 Packet -40 kHz	-500 kHz	500 kHz

a. External if Option B7E is not installed.

Monitor Band/Channel (MON)

To access the keys for setting up a monitor band/channel measurement, press **MEASURE**, **Monitor Band/Channel**, and then the front panel **Meas Setup** key.

Avg Number

Used to specify the number of data acquisitions that will be averaged. After the specified number of average counts, the averaging mode (terminal control) setting determines the averaging action.

On Sets measurement averaging on.

Off Sets measurement averaging off.

Front Panel default is Off.

Avg Mode

Used to select the type of termination control for the averaging function. This determines the averaging action after the specified number of data acquisitions (average count) is reached.

Exp After the average count is reached, each successive data acquisition is exponentially weighted and combined with the existing average.

Repeat After reaching the average count, the averaging is reset and a new average is started.

The default value is Exp.

Method

Used to select the method used for monitoring. Possible values are **Channel** and **Band**.

The default value is **Band**.

Channel Span

Used to toggle between monitoring the current channel by itself (One) or the channel and the three channels on either side of it (Three). **Channel Span** is grayed out when **Method** is set to Band.

The default value is One.

Meas Setup

**Chan Setup/
Band Setup**

Chan Setup is displayed when **Method** is set to **Channel**. **Band Setup** is displayed when **Method** is set to **Band**. Both provide access to the following keys:

- Res BW** Used to change the 3 dB resolution bandwidth in a 1, 3, 10 sequence. The default value is 100 kHz.
- Video BW** Used to change the analyzer post detect filter in a 1, 3, 10 sequence. The default value is 100 kHz.
- Max Hold** Displays a trace of the maximum values for a measurement. The default value is Off.
- Detector** Used to change the type of video detection used. Possible values are Peak, Sample and Neg Peak. **Detector** is grayed out when **Method** is set to Band. The default value is Peak.
- Sweep Time** Used to set the sweep time. The default is 2 seconds.

**Restore Meas
Defaults**

Restores all **Meas Setup** parameter values for the current measurement to their factory defaults.

Default Settings

The following table shows the default settings for the Monitor Band/Channel measurement.

Parameter	Default	Min	Max
		or Selections	
Avg Number	Off	0	1000
Avg Mode	Exp	Exp, Repeat	
Detector	Peak	Peak, Sample, Neg Peak	
Method	Band	Band, Channel	
Res BW	100 kHz	1 kHz-Band 10 Hz-Channel ^a	5 MHz
Video BW	100 kHz	30 Hz	3 MHz
Sweep Time	2 seconds	5 ms	4 ks

a. Requires Option 1DR

Initial Carrier Frequency Tolerance (ICFT)

To access the keys for setting up an initial carrier frequency tolerance measurement, press **MEASURE**, **Init Carrier Freq Tol**, and then the front panel **Meas Setup** key.

Avg Number	<p>Used to specify the number of data acquisitions that will be averaged. After the specified number of average counts, the averaging mode (terminal control) setting determines the averaging action.</p> <p>On Sets measurement averaging on.</p> <p>Off Sets measurement averaging off.</p> <p>Front Panel default is Off.</p>
Avg Mode	<p>Used to select the type of termination control for the averaging function. This determines the averaging action after the specified number of data acquisitions (average count) is reached.</p> <p>Exp After the average count is reached, each successive data acquisition is exponentially weighted and combined with the existing average.</p> <p>Repeat After reaching the average count, the averaging is reset and a new average is started.</p> <p>The default value is Exp.</p>
Trig Source	<p>Used to select the trigger source for the measurement. Possible values are Free Run, External, and RF Burst (Option B7E required).</p> <p>The default value is RF Burst. If the analyzer does not have Option B7E installed, the default will be External.</p>
Burst Sync	<p>Used to select how the measurement will synchronize with the correct part of the burst. Valid choices are Preamble and None. Preamble uses p0 to define the start of the burst.</p> <p>The default value is Preamble.</p>
Limit Test	<p>Turns limit checking on and off, controlling whether or not the relevant PASS/FAIL annotation is displayed in the measurement bar and beside each result.</p>
Limits	<p>Provides access to the following parameters:</p> <p>ICFT Upper Limit Range 0 Hz to 500 kHz</p> <p>ICFT Lower Limit Range -500 kHz to 0 Hz</p>
Restore Meas Defaults	<p>Restores all Meas Setup parameter values for the current measurement to their factory defaults.</p>

Default Settings

The following table shows the default settings for the Initial Carrier Frequency Tolerance measurement.

Parameter	Default	Min	Max
		or Selections	
Avg Number	Off	0	1000
Avg Mode	Exp	Exp, Repeat	
Trig Source	RF Burst ^a	Free Run, RF Burst, External	
Burst Sync	Preamble	Preamble, None	
ICFT Upper Limit	75 kHz	0 Hz	500 kHz
ICFT Lower Limit	-75 kHz	-500 kHz	0 Hz

a. External if Option B7E is not installed.

Modulation Characteristics (MCH)

To access the keys for setting up a modulation characteristics measurement, press **MEASURE**, **Modulation Chars** and then the front panel **Meas Setup** key.

Avg Number

Used to specify the number of data acquisitions that will be averaged. After the specified number of average counts, the averaging mode (terminal control) setting determines the averaging action.

On Sets measurement averaging on.

Off Sets measurement averaging off.

Front Panel default is Off.

Avg Mode

Used to select the type of termination control for the averaging function. This determines the averaging action after the specified number of data acquisitions (average count) is reached.

Exp After the average count is reached, each successive data acquisition is exponentially weighted and combined with the existing average.

Repeat After reaching the average count, the averaging is reset and a new average is started.

The default value is Exp.

Hold Result

Used to store the measurement result for either $\Delta f1$ Avg or $\Delta f2$ Avg depending on which result has been measured. If you have selected a valid result, then the display item for that result will change color to yellow.

Hold Result may not be used when:

- the measurement has not completed the full number of averages, or
- the measurement is in the idle state and the result data is or has become invalid.

Pressing the **Restart** key will complete the second part of the measurement (assuming the correct signal type is connected) and display the remaining results when finished.

If the **Restart** key is pressed and the other payload data is not recognized (with **Payload Data** set to Auto), then the measurement will return to the idle state without invalidating the results. This way you have the option to connect the correct signal and still keep the results for the previous signal type obtained earlier.

Payload Data	<p>Used to choose the expected payload data pattern (11110000 or 10101010), or to let the measurement auto-detect the pattern.</p> <p>If you select a specific pattern, then the measurement will assume that the signal being supplied is correct.</p> <p>If you select Auto, then the measurement will complete successfully only if one of the two expected patterns is received. If the pattern is not received, the measurement will abort to the idle state, although it will not invalidate any previously attained results. Setting Hold Result to Off will cause all result data to become invalid.</p>
Trig Source	<p>Used to select the trigger source for the measurement. Possible values are Free Run, External, and RF Burst (Option B7E required).</p> <p>The default value is RF Burst. If the analyzer does not have Option B7E installed, the default will be External.</p>
Burst Sync	<p>Used to select how the measurement will synchronize with the correct part of the burst. Valid choices are Preamble and None. Preamble uses p0 to define the start of the burst.</p> <p>The default value is Preamble.</p>
Limit Test	<p>Turns limit checking on and off, controlling whether or not the relevant PASS/FAIL annotation is displayed in the measurement bar and beside each result.</p>
Limits	<p>Provides access to the following parameters:</p> <p>$\Delta f2/\Delta f1$</p> <p>Lower Limit This is the lower limit of the deviation ratio. This is the ratio of $\Delta f2$ avg to $\Delta f1$ avg expressed as a percentage. The maximum expected value is around 88% due to the 0.5 BT Gaussian filter.</p> <p>$\Delta f1$ avg</p> <p>Upper Limit This is the upper limit of $\Delta f1$ avg recorded over the duration of the payload. All values of $\Delta f1$ avg measured over the entire packet must fall between 140 kHz and 175 kHz. Use this parameter to change the upper limit from the default value of 175 kHz.</p> <p>$\Delta f1$ avg</p> <p>Lower Limit This is the lower limit of $\Delta f1$ avg recorded over the duration of the payload. All values of $\Delta f1$ avg measured over the entire packet must fall between 140 kHz and 175 kHz. Use this parameter to change the lower limit from the default value of 140 kHz.</p> <p>$\Delta f2$ max</p> <p>Lower Limit This is the upper limit of $\Delta f2$ max recorded over the duration of the payload. All values of $\Delta f2$ max measured over the entire packet must be at least 115 kHz. Use this parameter to change the lower limit from the default value of 115 kHz.</p>

Payload View Allows you to toggle the view offset to show either the preamble or the payload. If **Payload View** is On, a reference marker is drawn to indicate the start of the payload header. An indicator is displayed to the left edge of the screen if the offset causes the bit0 marker to fall off the screen. An additional reference marker will always be fixed at zero offset.

Restore Meas Defaults Restores all **Meas Setup** parameter values for the current measurement to their factory defaults.

Advanced Provides access to the following advanced measurement parameter settings:

$\Delta f1$ RBW Allows you to change the resolution bandwidth filter used when calculating $\Delta f1$.

The default value is 3 MHz

$\Delta f2$ RBW Allows you to change the resolution bandwidth filter used when calculating $\Delta f2$.

The default value is 3 MHz

Default Settings

The following table shows the default settings for the Modulation Characteristics measurement.

Parameter	Default	Min	Max
		or Selections	
Avg Number	Off	0	1000
Avg Mode	Exp	Exp, Repeat	
Payload Data	Auto	Auto 11110000 10101010	
Trig Source	RF Burst ^a	Free Run, RF Burst, External	
Burst Sync	Preamble	Preamble, None	
Payload View	Off	On, Off	
$\Delta f1$ RBW	3 MHz	10 Hz ^b	3 MHz
$\Delta f2$ RBW	3 MHz	10 Hz ^b	5 MHz
$\Delta f2/\Delta f1$ Lower Limit	80.000%	0%	100%
$\Delta f1$ avg Upper Limit	175 kHz	0 Hz	500 kHz
$\Delta f1$ avg Lower Limit	140 kHz	0 Hz	500 kHz
$\Delta f2$ max Lower Limit	115 kHz	0 Hz	500 kHz

a. External if Option B7E is not installed.

b. Requires Option 1DR.

For non-Option 1DR instruments, minimum RBW is 1 kHz.

Output Spectrum Bandwidth (OSBW)

To access the keys for setting up an output spectrum bandwidth measurement, press **MEASURE**, **Output Spectrum BW** and then the front panel **Meas Setup** key.

Avg Number	Used to specify the number of data acquisitions that will be averaged. After the specified number of average counts, the averaging mode (terminal control) setting determines the averaging action.
On	Sets measurement averaging on.
Off	Sets measurement averaging off.
	Front Panel default is Off.
Avg Mode	Used to select the type of termination control for the averaging function. This determines the averaging action after the specified number of data acquisitions (average count) is reached.
Exp	After the average count is reached, each successive data acquisition is exponentially weighted and combined with the existing average.
Repeat	After reaching the average count, the averaging is reset and a new average is started.
	The default value is Exp.
X dB	Used to change the level where the markers will be placed below the peak level of the carrier. The frequency between these two markers is measured as the output spectrum bandwidth.
Limit Test	Turns limit checking on and off, controlling whether or not the relevant PASS/FAIL annotation is displayed in the measurement bar and beside each result.
Limits	Used to set the Upper Limit of the output spectrum bandwidth. The numeric output spectrum bandwidth is checked against this limit, and if the bandwidth is greater than the limit, the measurement display will append a red “F” to the value, indicating a FAIL condition.
Restore Meas Defaults	Restores all Meas Setup parameter values for the current measurement to their factory defaults.
Advanced	Provides access to the following advanced parameter settings:
Res BW	Set the resolution bandwidth for this measurement.
Video BW	Set the video bandwidth for this measurement.
Sweep Time	Set the sweep time for this measurement.
Max Hold	Turn the maximum hold trace function on or off.

Default Settings

The following table shows the default settings for the output spectrum bandwidth measurement.

Parameter	Default	Min	Max
		or Selections	
Avg Number	Off	0	1000
Avg Mode	Exp	Exp, Repeat	
X dB	-20.0 dB	-50 dB	-5 dB
Limit Test	On	On, Off	
Upper Limit	1 MHz	-5 MHz	5 MHz
Res BW	10 kHz	1 kHz	5 MHz
Video BW	30 kHz	30 Hz	3 MHz
Sweep Time	1 s	5 ms	4 ks
Max Hold	On	On, Off	

Adjacent Channel Power (ACP)

To access the keys for setting up an adjacent channel power measurement, press **MEASURE, ACP** and then the front panel **Meas Setup** key. The measurement is made across the full Bluetooth™ operating spectrum.

Avg Number On Off	Allows the user to turn averaging on or off and set the number of averages to be used when averaging is on. When Fast ACP Meas is on, this parameter is set to 10, turned on, and the key disabled.
Avg Mode Exp Repeat	Allows the user to change between exponential and repeat averaging. When Fast ACP Meas is on, this parameter is set to repeat and the key disabled.
Table Index (Channel)	Allows you to select the measurement results of a particular channel. When the measurement is running it will automatically update the display showing the latest result.
Fast ACP Meas On Off	Turns Fast ACP on and off.
Limit Test On Off	Turns limit checking on and off, controlling whether or not the relevant PASS/FAIL annotation is displayed in the measurement bar and beside each result.
Limits	Used to set the Far Limit and Near Limit. The numeric peak and average power is checked against peak upper limit, average upper limit, and average lower limit parameters, and if the values is greater than the limits, the measurement display will append a red “F” to the value, indicating a FAIL condition.
	Far Limit Allows you to set the value of the limit for the sum of the peak power in the spectrum greater than two channels from the transmit channel center frequency.
	Near Limit Allows you to set the value of the limit for the sum of the peak power in the spectrum two channels from the transmit channel center frequency
Restore Meas Defaults	Restores all Meas Setup parameter values for the current measurement to their factory defaults.

Default Settings

The following table shows the default settings for the adjacent channel power measurement.

Parameter	Default	Min	Max
		or Selections	
Avg Number	10	1	1000
Avg Mode	Repeat	Exp, Repeat	n/a
Table Index (Channel)	0	0	78
Limit Test	On	On, Off	
Far Limit	-40 dBm	-90 dBm	0 dBm
Near Limit	-20 dBm	-90 dBm	0 dBm

MODE

The **MODE** front panel key provides access to menu keys for selecting the analyzer measurement mode.

The basic spectrum analyzer comes with only SA mode installed. Measurement personality firmware must be installed for other **MODE** menu keys to be labelled and functional.

Spectrum Analyzer

Accesses the base-instrument spectrum analyzer mode menu keys.

Bluetooth

Accesses the Bluetooth™ measurement personality menu keys and associated functions.

Mode Setup

The **Mode Setup** front panel key provides access to screens for setting up parameters that apply to all measurements for the selected mode. This contrasts to the **Meas Setup** hardkey which provides access to parameters which are measurement specific.

Radio

Provides access to a screen enabling the following parameters to be changed:

- Device** Select the power class of the Bluetooth™ device to be measured. Choices are Power Class 1, 2, or 3.
- Freq Hopping** Specify if the Bluetooth™ device is in the standard (hopping) mode or in test mode (not hopping).
- Software Enh. Triggering** Specify if the Bluetooth™ device is in the standard triggering mode or the Software Enhanced Triggering mode.

Default Settings

The following table shows the **Radio** default settings.

Radio Default Settings	
Device	Power Class 1
Freq Hopping	Off
Software Enh. Triggering	Off

Input

Provides access to a screen with the same parameters as described in the **Input** key section on [page 66](#).

Trigger

Provides access to a screen with the same parameters as described in the **Trigger** key section on [page 94](#).

Demod

Provides access to a screen with the same parameters as described in the **Det/Demod** key section on [page 61](#).

Properties

The **Properties** key accesses a screen displaying the Bluetooth™ Application Version.

Packet Data

The **Packet Data** key accesses a screen displaying the following parameters:

Access Code

+ Header Number of bits which total the Bluetooth™ packet Access Code and Header.

Payload

Header Length Number of bits which make up the DH1, DH3, or DH5 Packet Payload Header.

Payload

Data Length Number of data bits which make up the DH1, DH3, or DH5 Payload Data. The default value does not include the 16 CRC bits.

Payload

CRC Length Number of bits which make up the DH1, DH3, or DH5 Cyclic Redundancy Check (CRC) length. The default value is 16 bits.

Default Settings

The following table shows the default settings for the Packet Data screen. The default settings are based on the Bluetooth™ standard and shouldn't need to be changed.

Packet Data Default Settings			
Access Code + Header		126 bits	
Packet Type	Payload:		
	Header Length	Data Length	CRC Length
DH1	8 bits	216 bits	16 bits
DH3	16 bits	1464 bits	16 bits
DH5	16 bits	2712 bits	16 bits

Trigger

The **Trig** front panel key provides access to menu keys for selecting the following trigger sources:

- External** Activates the rear panel external trigger input.
- RF Burst** Activates an RF burst envelope trigger that has automatic level control for periodic burst signals. (Requires Option B7E)
- Video** Activates the trigger condition that allows the next sweep to start if the detected RF envelope voltage rises to a level set by the video trigger level. When **Video** is pressed, a line appears on the display. The analyzer triggers when the input signal exceeds the trigger level at the left edge of the display. You can change the trigger level using the step keys, the knob, or the numeric keypad or by using the Trigger form. The default video trigger level is -3.5 dB of the peak power.

Pressing the **Trig** key enables you to set the **Delay**, **Level**, and **Slope** for each trigger source where applicable. Note that the trigger source for each measurement may be selected separately (under the **Meas Setup** key).

- Delay** For trigger delay use positive values. For pre-trigger, use negative values.
- Level** For the RF Burst selection, the level is relative to the peak level of the RF signal.
- Slope** Select from **Positive** or **Negative** to trigger on the leading edge (**Pos**) or the trailing edge (**Neg**) of the signal.

Default Settings

The following table shows the trigger default settings.

Trigger Default Settings			
	External	RF Burst	Video
Delay	0.000 s	0.000 s	0.000 s
Level	N/A	-6.00 dBc	-3.5 dBc
Slope	Pos	N/A	N/A

View/Trace

The **ViewTrace** front panel key leads to one of the following Bluetooth™ measurement view/display menus depending on which measurement is selected when the key is pressed. Used to select between different measurement views where appropriate.

Measurement	View/Trace available
Modulation Overview	FM Deviation
Output Power	RF Envelope
Carrier Frequency Drift	FM Deviation
Monitor Band/Channel	Spectrum
Initial Carrier Frequency Tolerance	FM Deviation
Modulation Characteristics	FM Deviation
Output Spectrum Bandwidth	Spectrum
Adjacent Channel Power	RF Envelope Spectrum

If you have a Problem

Your analyzer is built to provide dependable service. However Agilent Technologies worldwide sales and service organization is ready to provide the support if you:

- Experience a problem.
- Desire additional information.
- Wish to order parts, options, or accessories.

In general, a problem can be caused by a hardware failure, a software error, or a user error. Follow these general steps to determine the cause and to resolve the problem.

1. Perform the quick checks listed in “Check the Basics” in this chapter. It is possible that a quick check may eliminate your problem altogether.
2. If the problem is a hardware problem, you have two options:
 - a. Repair it yourself (see the “Service Options” section in this chapter).

WARNING

There are no operator serviceable parts inside the analyzer. Refer servicing to qualified personnel. To prevent electrical shock do not remove covers.

- b. Return the analyzer to Agilent Technologies for repair. If the analyzer is still under warranty or is covered by an Agilent Technologies maintenance contract, it will be repaired under the terms of the warranty or plan (the warranty is at the front of this manual).

If the analyzer is no longer under warranty or is not covered by an Agilent Technologies maintenance plan, Agilent Technologies will notify you of the cost of the repair after examining the instrument. See “How to Call Agilent Technologies” and “How to Return Your Analyzer for Service” for more information.

3. If the problem is a software problem, you have two options:
 - a. Reinstall the firmware and or the measurement personality DLP.
 - b. Return the analyzer to Agilent Technologies for repair. If the analyzer is still under warranty or is covered by an Agilent Technologies maintenance contract, it will be repaired under the terms of the warranty or plan (the warranty is at the front of this manual).

If the analyzer is no longer under warranty or is not covered by an Agilent Technologies maintenance plan, Agilent Technologies will notify you of the cost of the repair after examining the instrument. See [“How to Call Agilent Technologies”](#) and [“How to Return Your Analyzer for Service”](#) for more information.

Before You Call Agilent Technologies

Check the Basics

A problem can often be resolved by repeating the procedure that you were following when the problem occurred. Before calling Agilent Technologies or returning the analyzer for service, please perform the following checks:

- Check the line fuse.
- Is there power at the receptacle?
- Is the analyzer turned on? Make sure the fan is running, which indicates that the power supply is on.
- If the display is dark or dim, press the upper **Viewing Angle** key in the upper-left corner of the front panel. If the display is too bright, adjust the lower **Viewing Angle** key in the upper-left corner of the front panel.
- If other equipment, cables, and connectors are being used with your Agilent Technologies ESA spectrum analyzer, make sure they are connected properly and operating correctly.
- Is the input coupling set correctly? Refer to the “Selecting Input Coupling” information in the *Agilent Technologies ESA Spectrum Analyzers User’s Guide* to determine the appropriate setting.
- Review the procedure for the measurement being performed when the problem appeared. Are all the settings correct?
- If the analyzer is not functioning as expected, return the analyzer to a known state by pressing the **Preset** key.

Some analyzer settings are not affected by a Preset. If you wish to reset the analyzer configuration to the state it was in when it was originally sent from the factory, press **System, Power On/Preset, Preset (Factory), Preset** (on the front panel).

- Is the measurement being performed, and the results that are expected, within the specifications and capabilities of the analyzer? Refer to the “Specifications and Characteristics” chapters in the *Agilent Technologies ESA Spectrum Analyzers Specifications Guide* for analyzer specifications.
- In order to meet specifications, the analyzer must be aligned. Either Auto Align All must be selected (press **System, Alignments, Auto Align, All**), or the analyzer must be manually aligned at least once per hour, or whenever the temperature changes more than 3° centigrade. When **Auto Align, All** is selected, AA appears on the left edge of the display.
- Perform an **Align Now, All**. If the analyzer is an Agilent E4402B, E4403B, E4404B, E4405B, E4407B, or E4408B, connect a cable between the AMPTD REF OUT and the INPUT 50 Ω. Press **System, Alignments, Align Now, All**.

If the analyzer is equipped with a 3.0 GHz tracking generator (Option 1DN on Agilent Technologies E4402B, E4403B, E4404B, E4405B, E4407B, or E4408B), connect a short cable from AMPTD REF OUT to INPUT 50 Ω , and press **System, Alignments, Align Now, TG**. If the analyzer is equipped with FM Demod (Option BAA), press **System, Alignments, Align Now, FM Demod**.

- If the previously performed alignments did not resolve the problem, press **System, Alignments, Load Defaults**. Now press **System, Alignments, Align Now, All**. If the analyzer is an Agilent Technologies E4402B, E4403B, E4404B, E4405B, E4407B, or E4408B, be sure to connect a cable from AMPTD REF OUT to INPUT 50 Ω . Since **Load Defaults** has been performed, the analyzer will perform three complete alignment sequences.
- Is the analyzer displaying an error message? If so, refer to “Error Messages” in the *Agilent Technologies ESA Spectrum Analyzers User’s Guide*.
- If the necessary test equipment is available, perform the performance verification tests in the *Agilent Technologies ESA Spectrum Analyzers Specifications Guide - E Series* or *Agilent Technologies ESA Spectrum Analyzers Specifications Guide - L Series*. Record all results on a Performance Verification Test Record form which follows the tests.
- If the equipment to perform the performance verification tests is not available, you may still be able to perform the functional checks in the *Agilent Technologies ESA Spectrum Analyzers User’s Guide*.

Read the Warranty

The warranty for your analyzer is at the front of this manual. Please read it and become familiar with its terms.

If your analyzer is covered by a separate maintenance agreement, please be familiar with its terms.

Service Options

Agilent Technologies offers several optional maintenance plans to service your analyzer after the warranty has expired. Call your Agilent Technologies sales and service office for full details.

If you want to service the analyzer yourself after the warranty expires, you can purchase the service documentation that provides all necessary test and maintenance information.

You can order the service documentation, **Option OBW** (assembly level troubleshooting and adjustment procedures) and **Option OBV** (component level information including parts lists, component location diagrams and schematic diagrams), through your Agilent Technologies sales and service office. Service documentation is described under “Service Documentation and Adjustment Software (Option OBW)” and “Component Level Service Documentation (Option OBV)” in *ESA Spectrum Analyzers User’s Guide*.

How to Call Agilent Technologies

Agilent Technologies has call centers around the world to provide you with complete support for your analyzer. To get assistance with all your test and measurement needs, get in touch by internet, phone, or fax, with the nearest Agilent Technologies call center listed in [Table 6-1](#). In any correspondence or telephone conversations, refer to your analyzer by its product number, full serial number, and firmware revision. (Press **System**, **More**, **Show System**, and the product number, serial number, and firmware revision information will be displayed on your analyzer screen.) A serial number label is also attached to the rear panel of the analyzer.

Table 6-1 Getting in Touch With Agilent

Online assistance: www.agilent.com/find/assist			
United States (tel) 1 800 452 4844	Japan (tel) (+81) 426 56 7832 (fax) (+81) 426 56 7840	New Zealand (tel) 0 800 738 378 (fax) (+64) 4 495 8950	Europe (tel) (+31) 20 547 2323 (fax) (+31) 20 547 2390
Canada (tel) 1 877 894 4414 (fax) (905) 282 6495	Latin America (tel) (305) 269 7500 (fax) (305) 269 7599	Australia (tel) 1 800 629 485 (fax) (+61) 3 9210 5947	

Asia Call Center Numbers		
Country	Phone Number	Fax Number
Singapore	1-800-375-8100	(65) 836-0252
Malaysia	1-800-828-848	1-800-801664
Philippines	(632) 8426802 1-800-16510170 (PLDT Subscriber Only)	(632) 8426809 1-800-16510288 (PLDT Subscriber Only)
Thailand	(088) 226-008 (outside Bangkok) (662) 661-3999 (within Bangkok)	(66) 1-661-3714
Hong Kong	800-930-871	(852) 2506 9233
Taiwan	0800-047-866	(886) 2 25456723
People's Republic of China	800-810-0189 (preferred) 10800-650-0021	10800-650-0121
India	1-600-11-2929	000-800-650-1101

How to Return Your Analyzer for Service

Service Tag

If you are returning your analyzer to Agilent Technologies for servicing, fill in and attach a blue service tag. Several service tags are supplied at the end of this chapter. Please be as specific as possible about the nature of the problem. If you have recorded any error messages that appeared on the display, or have completed a Performance Test Record, or have any other specific data on the performance of your analyzer, please send a copy of this information with your analyzer.

Original Packaging

Before shipping, pack the unit in the original factory packaging materials, if they are available. If the original materials were not retained, see “[Other Packaging](#)”.

NOTE Ensure that the instrument handle is in the rear-facing position in order to reduce the possibility of damage during shipping. Refer to [Figure 6-1](#).

NOTE Install the transportation disk into the floppy drive to reduce the possibility of damage during shipping. If the original transportation disk is not available, a blank floppy may be substituted.

If You Have a Problem
How to Return Your Analyzer for Service

Figure 6-1

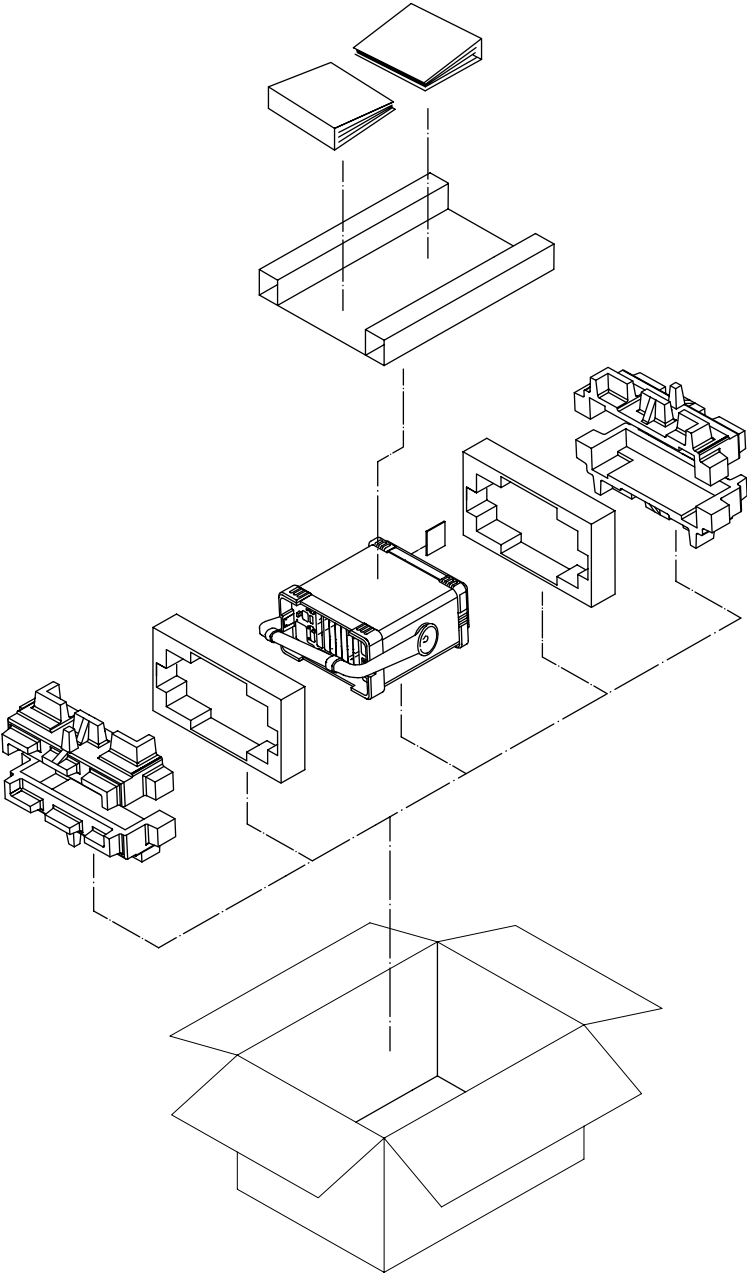

form122

Other Packaging

CAUTION

Analyzer damage can result from using packaging materials other than those specified. Never use styrene pellets in any shape as packaging materials. They do not adequately cushion the equipment or prevent it from shifting in the carton. They cause equipment damage by generating static electricity and by lodging in the analyzer louvers, blocking airflow.

You can repackage the instrument with commercially available materials, as follows:

1. Attach a completed service tag to the instrument.
2. Install the transportation disk or a blank floppy disk into the disk drive.
3. If you have a front-panel cover, install it on the instrument. If you do not have a front panel cover, make sure the instrument handle is in the forward-facing position to protect the control panel.
4. Wrap the instrument in antistatic plastic to reduce the possibility of damage caused by electrostatic discharge.
5. Use a strong shipping container. The carton must be both large enough and strong enough to accommodate the analyzer. A double-walled, corrugated cardboard carton with 159 kg (350 lb) bursting strength is adequate. Allow at least 3 to 4 inches on all sides of the analyzer for packing material.
6. Surround the equipment with three to four inches of packing material and prevent the equipment from moving in the carton. If packing foam is not available, the best alternative is S.D.-240 Air Cap™ from Sealed Air Corporation located in Hayward, California, 94545; telephone number (510) 887-8090. Air Cap looks like a plastic sheet filled with 1-1/4 inch air bubbles. Use the pink-colored Air Cap to reduce static electricity. Wrapping the equipment several times in this material should both protect the equipment and prevent it from moving in the carton.
7. Seal the shipping container securely with strong nylon adhesive tape.
8. Mark the shipping container “FRAGILE, HANDLE WITH CARE” to assure careful handling.
9. Retain copies of all shipping papers.

If You Have a Problem
How to Return Your Analyzer for Service

Index

Numerics

- 10 MHz REF INPUT, 19
- 10 MHz REF OUTPUT, 19

A

- access code + header
 - changing, 93
- active function area, 20
- active license key, 26
- additional information, 15
- adjacent channel power
 - Avg Mode key, 89
 - Avg Number key, 89
 - default settings, 90
 - Fast ACP Meas key, 89
 - meas setup, 89
 - menu map, 54
- Advanced key
 - modulation characteristics, 85
 - output spectrum bandwidth, 87
- annotation, 20
- application notes, 15, 25
- authentication, 12
- averaging indicator, 21
- Avg Mode key
 - adjacent channel power, 89
 - carrier frequency drift, 76
 - initial carrier frequency tolerance, 81
 - modulation characteristics, 83
 - modulation overview, 71
 - monitor band/channel, 79
 - output power, 73
 - output spectrum bandwidth, 87
- Avg Number key
 - adjacent channel power, 89
 - carrier frequency drift, 76
 - initial carrier frequency tolerance, 81
 - modulation characteristics, 83
 - modulation overview, 71
 - monitor band/channel, 79
 - output power, 73
 - output spectrum bandwidth, 87
- Avg Type key
 - output power, 73

B

- Bluetooth
 - measurement personality, 14
 - measurements, 14
 - standards, 8
 - understanding, 7
- Bluetooth mode
 - setting up, 33
- branch key, 21
- Burst Search Pre-Trigger key, 61

- Burst Search Threshold key, 61
- burst sync, 21
- Burst Sync key
 - carrier frequency drift, 76
 - initial carrier frequency tolerance, 81
 - modulation characteristics, 84
 - modulation overview, 72
 - output power, 73

C

- calling Agilent Technologies, 102
- carrier frequency, 10
- carrier frequency drift
 - default settings, 78
 - meas setup, 76
 - menu map, 49
- Center Freq key, 64
- CF step size, 69
- Chan Setup/Band Setup key, 80
- channel, 20
- Channel Index key
 - ACP, 89
- Channel key, 64
- Channel Span key, 79
- checking the basics, 100
- Choose Option key, 27
- connector
 - 10 MHz ref input, 19
 - 10 MHz ref output, 19
- CRC, 93
- current measurement, 20
- cyclic redundancy check, 93

D

- data rate, 8
- Demod, 92
- Det/Demod
 - front panel key, 61
 - menu map, 39
- Device
 - changing, 92
- digital communications
 - understanding, 25
- Display
 - front panel key, 62
 - menu map, 40
- display annotation, 20
- Display Line key, 62
- documentation, 24
- DSP, 19

E

- encryption, 12
- error correction, 12
- External Atten key, 67

- external frame sync, 19
- External Gain key, 66
- external reference in, 19
- external trigger, 94

F

- Fast ACP Meas key
 - adjacent channel power, 89
- fast ADC, 19
- features
 - front panel, 18
- File
 - front panel key, 63
 - menu map, 41
- file name, 36
- firmware update, 25
- FREQUENCY Channel
 - front panel key, 64
- frequency hopping, 8, 92
- FREQUENCY/Channel
 - menu map, 42
- front panel features, 18
- front panel key
 - Det/Demod, 61
 - Display, 62
 - File, 63
 - FREQUENCY Channel, 64
 - Input, 66
 - Marker, 68
 - Meas Setup, 71
 - MEASURE, 70
 - MODE, 91
 - Mode Setup, 92
 - Trig, 94
 - View/Trace, 95
- front panel key reference, 59

H

- hardware problems, 98
- Hold Result key
 - modulation characteristics, 83
- hopping, 8, 10, 92
- how to call Agilent Technologies, 102
- how to return your analyzer for service, 103

I

- industry standards, 14
- information
 - other sources, 15
- initial carrier frequency tolerance
 - default settings, 82
 - meas setup, 81
 - menu map, 51
- initial settings, 34

Index

- Input
 - front panel key, 66
 - menu map, 43
 - Input Atten key, 66
 - Input key, 92
 - Install Now key, 27
 - installation disk set, 27
 - installer troubleshooting, 29
 - installing measurement personalities, 26
 - Internal Preamp key, 66
 - ISM band, 8

 - K**
 - key reference
 - front panel, 59

 - L**
 - L M H Channel key, 64
 - License key, 26
 - Limit Test key
 - adjacent channel power, 89
 - carrier frequency drift, 77
 - initial carrier frequency tolerance, 81
 - modulation characteristics, 84
 - output power, 74
 - output spectrum bandwidth, 87
 - Limits key
 - adjacent channel power, 89
 - carrier frequency drift, 77
 - initial carrier frequency tolerance, 81
 - modulation characteristics, 84
 - output power, 74
 - output spectrum bandwidth, 87
 - link control unit, 11
 - link type, 12

 - M**
 - Marker
 - front panel key, 68
 - marker
 - trace selection, 68
 - marker to center frequency, 69
 - Marker to center frequency step, 69
 - Marker Trace
 - menu map, 45
 - Marker Trace Auto A B C, 68
 - master unit, 11
 - Max Deviation key, 61
 - Max Total Power key, 66
 - Meas Setup
 - adjacent channel power, 89
 - carrier frequency drift, 76
 - front panel key, 71
 - initial carrier frequency tolerance, 81
 - menu maps, 47
 - modulation characteristics, 83
 - modulation overview, 71
 - monitor band/channel, 79
 - output power, 73
 - output spectrum bandwidth, 87
 - MEASURE key, 70
 - menu map, 46
 - measurement bar, 20
 - measurement information
 - other sources, 15
 - measurement results
 - saving, 36
 - Measurement Results key, 63
 - measurements
 - making, 35
 - one button, 35
 - preparing, 34
 - summary, 14
 - menu map
 - adjacent channel power setup, 54
 - carrier frequency drift setup, 49
 - Det/Demod, 39
 - Display, 40
 - File, 41
 - FREQUENCY/Channel, 42
 - initial carrier frequency tolerance setup, 51
 - Input, 43
 - Marker ->Menu, 44
 - Marker Trace, 45
 - MEASURE, 46
 - MODE, 55
 - Mode Setup, 56
 - modulation characteristics setup, 52
 - modulation overview setup, 47
 - monitor band/channel setup, 50
 - output power setup, 48
 - output spectrum bandwidth setup, 53
 - Trig, 57
 - View/Trace, 58
 - Method key
 - monitor band/channel, 79
 - MODE
 - front panel key, 91
 - menu map, 55
 - mode keys, 18
 - Mode Setup
 - Demod, 92
 - front panel key, 92
 - Input key, 92
 - menu map, 56
 - Packet Data, 93
 - Properties key, 92
 - Radio key, 92
 - Trigger, 92
 - modulation, 10
 - modulation characteristics
 - default settings, 86
 - meas setup, 83
 - menu map, 52
 - modulation overview
 - default settings, 72
 - meas setup, 71
 - menu map, 47
 - monitor band/channel
 - default settings, 80
 - meas setup, 79
 - menu map, 50

 - O**
 - one button measurements, 35
 - operating range, 8, 10
 - options, 22
 - 106, 23
 - 228, 23
 - AYX, 23
 - B72, 23
 - B7D, 23
 - B7E, 23
 - output power
 - default settings, 75
 - meas setup, 73
 - menu map, 48
 - output spectrum bandwidth
 - default settings, 88
 - meas setup, 87
 - menu map, 53

 - P**
 - packaging, 103
 - packet, 8
 - Packet Data key, 93
 - packet type, 12, 20, 21
 - Packet Type key, 64
 - pass/fail status, 21
 - Payload CRC Length
 - changing, 93
 - Payload Data key
 - modulation characteristics, 84
 - Payload Data Length
 - changing, 93
 - Payload Header Length
 - changing, 93
 - Payload View key, 85
 - Preferences key, 62
 - preparing to make measurements, 34
 - Properties, 92

 - R**
 - Radio key, 92
 - radio unit, 9
 - rear panel features, 19
 - replacement parts, 102
-

Index

- required options, 22
- reset, 34
- Restore Meas Defaults key
 - adjacent channel power, 89
 - carrier frequency drift, 77
 - initial carrier frequency tolerance, 81
 - modulation characteristics, 85
 - modulation overview, 72
 - monitor band/channel, 80
 - output power, 74
 - output spectrum bandwidth, 87
- returning your analyzer for service, 103
- rf burst trigger, 94
- RF characteristics, 10
- RF communications hardware, 19
- RF Input Range key, 66
- S**
 - sales and service offices, 102
 - saving measurement results, 36
 - screen annotation, 20
 - service, 102
 - service options, 101
 - service tag, 103
 - setting up the Bluetooth mode, 33
 - settings
 - initial, 34
 - shipment
 - verification list, 24
- slave unit, 11
- standards, 14
 - Bluetooth, 8
- Start Marker key
 - output power, 74
- Stop Marker key
 - output power, 74
- support, 102
- T**
 - Title key, 62
 - transmit power, 10
 - Trig
 - front panel key, 94
 - menu map, 57
 - trig source, 21
 - Trig Source key
 - carrier frequency drift, 76
 - initial carrier frequency tolerance, 81
 - modulation characteristics, 84
 - modulation overview, 71
 - output power, 73
 - Trigger, 92
 - trigger
 - external, 94
 - rf burst, 94
 - video, 94
 - troubleshooting
 - installer, 29
- U**
 - understanding Bluetooth, 7
 - understanding digital communications, 25
 - uninstalling measurement personalities, 26
 - updating firmware, 25
 - URL
 - ESA analyzer updates, 25
 - firmware, 25
- V**
 - video trigger, 94
 - View Offset key
 - carrier frequency drift, 76
 - modulation overview, 71
 - View/Trace
 - menu map, 58
 - View/Trace key, 95
- W**
 - warranty, 101
 - website
 - firmware updates, 25
- X**
 - X dB key
 - output spectrum bandwidth, 87

Index
